

## ASSEMBLY INSTRUCTIONS

MARIE WOOD FRAME UPHOLSTERED  
DINING CHAIR (SET OF 2)

*Signature*  
**MADISON PARK**

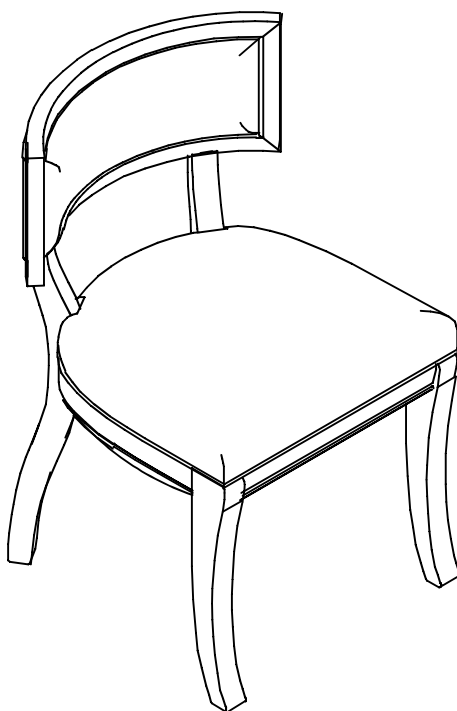

### Please read below before assembly

- Assemble the product on a flat, soft surface such as a carpet or cloth to prevent scratching the finish.
- Do not discard any content until assembly is complete to avoid accidentally discarding small parts or hardware.
- Take out all parts and hardware from box.
- Failure to follow these instructions may cause the bolts to misalign during assembly.

### DISCLAIMERS:

- WHEN PROPERLY ASSEMBLED, THIS ITEM IS SAFE FOR INTENDED USE. SELLER IS NOT LIABLE FOR ANY DAMAGES RESULTING FROM ITEM BEING IMPROPERLY ASSEMBLED AFTER PURCHASE.
- BOLTS MAY LOOSEN DURING NORMAL EVERYDAY USE. THEY SHOULD BE INSPECTED AT LEAST EVERY 3 MONTHS AND RE-TIGHTENED AS NEEDED TO PREVENT DAMAGE OR INJURY, AND ENSURE STABILITY.

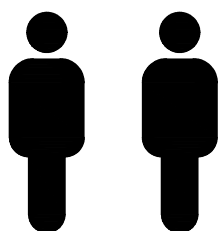

PEOPLE NEEDED



300





lbs seat

WEIGHT LIMIT





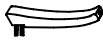



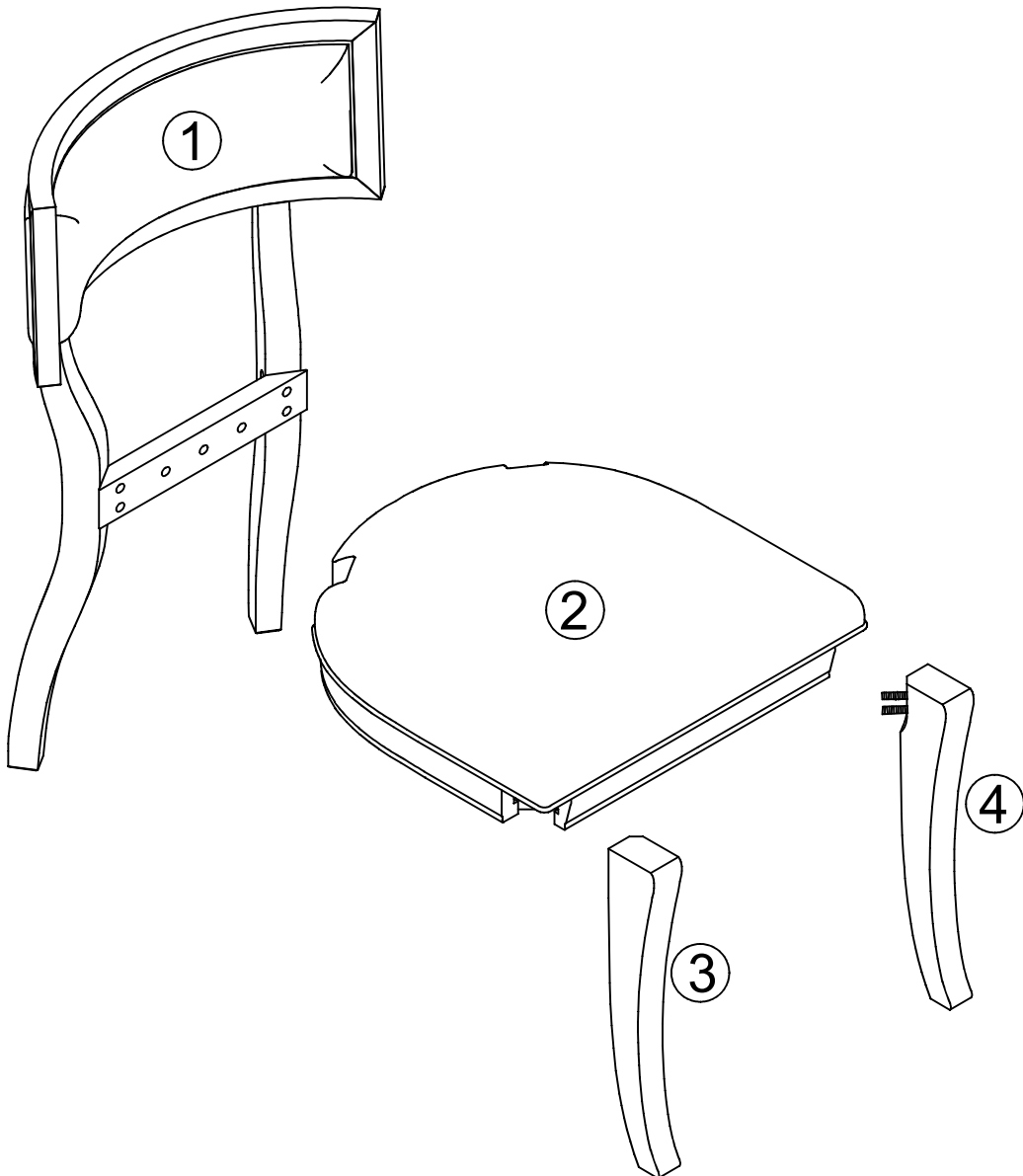

ESTIMATED TIME

# PARTS LIST

①	CHAIR BACK		1 PC
②	SEAT CUSHION		1 PC
③	LEFT FRONT LEG		1 PC
④	RIGHT FRONT LEG		1 PC





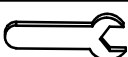

# HARDWARE LIST

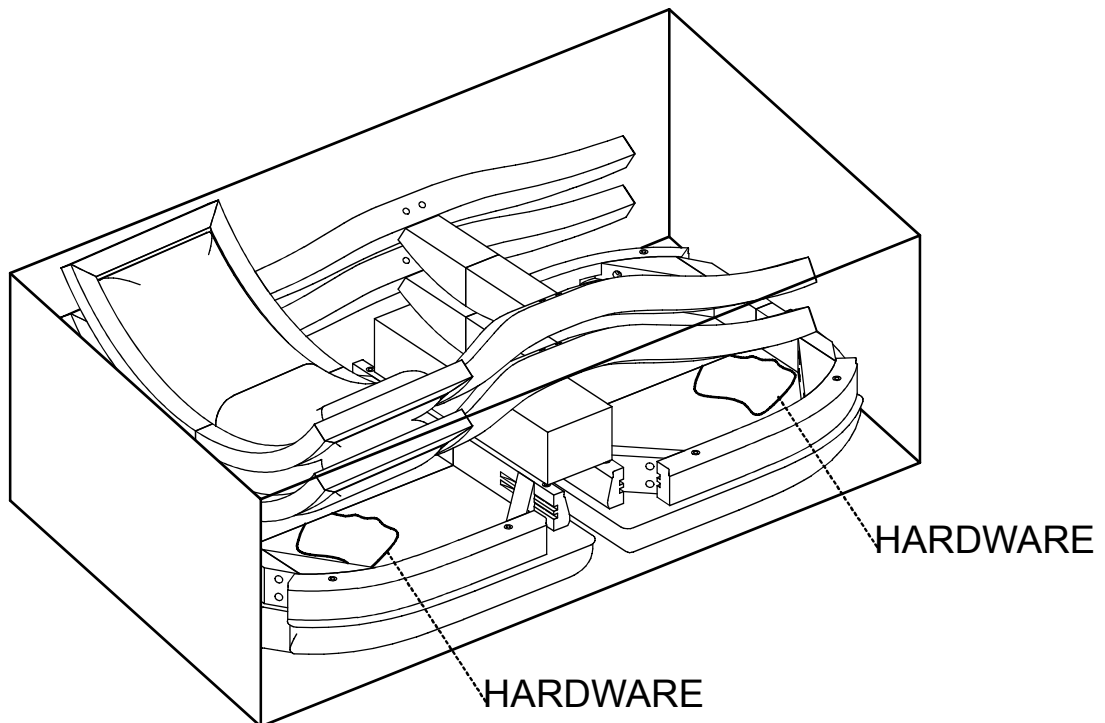
A	LARGE BOLT - Ø5/16" x 3"		4 PCS
B	SMALL BOLT - Ø1/4" x 1-3/4"		1 PC
C	SMALL LOCK WASHER - Ø1/4"		1 PC
D	SMALL FLAT WASHER - Ø1/4"		1 PC
E	ALLEN KEY		1 PC
F	HEXAGON NUT - Ø5/16"		4 PCS
G	LARGE LOCK WASHER - Ø5/16"		8 PCS
H	LARGE FLAT WASHER - Ø5/16"		8 PCS
I	WRENCH- 5/16"		1 PC

## STEP 1 LOCATE PARTS AND HARDWARE PER BELOW DRAWING

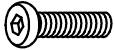



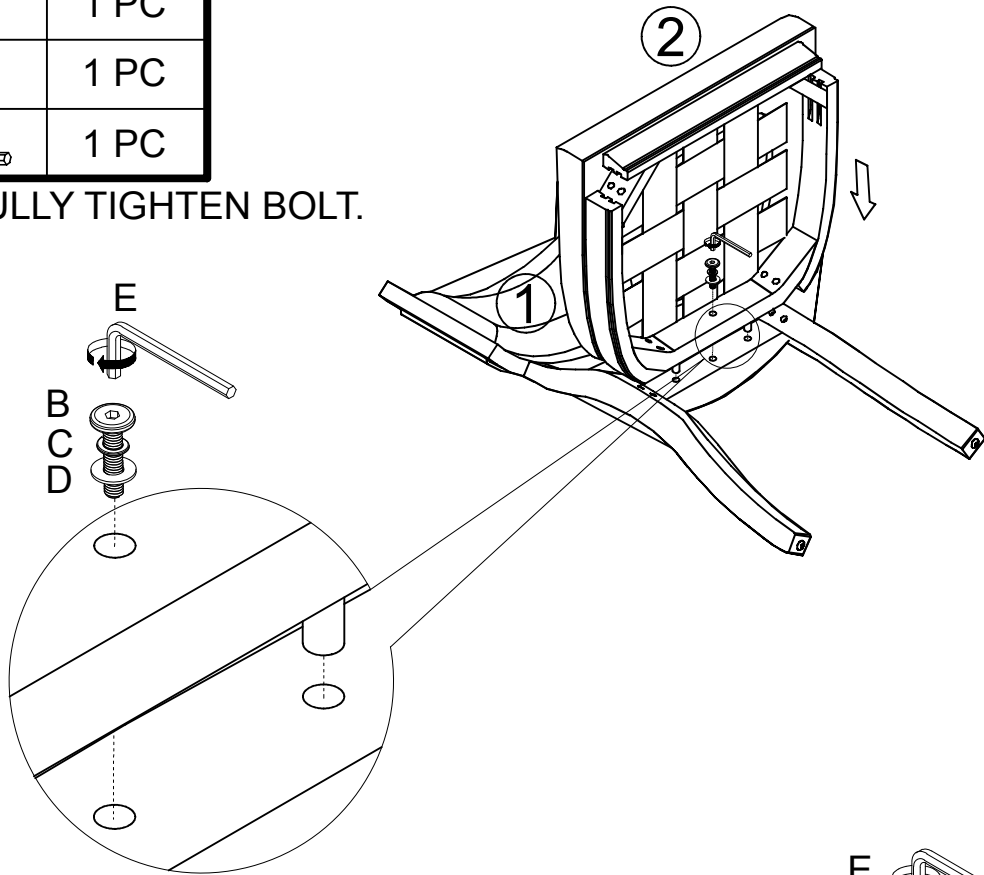

# STEP 2

B		1 PC
C		1 PC
D		1 PC
E		1 PC

\* DO NOT FULLY TIGHTEN BOLT.





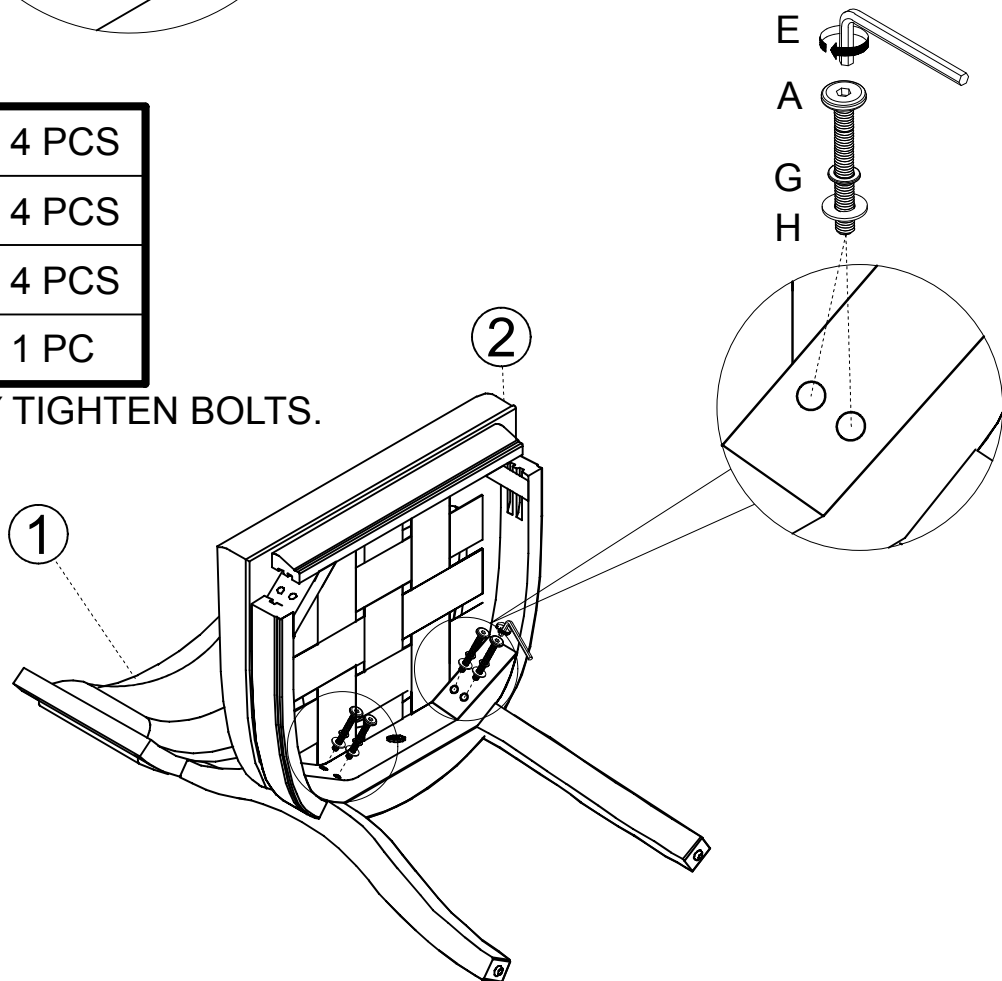

# STEP 3

A		4 PCS
G		4 PCS
H		4 PCS
E		1 PC

\* DO NOT FULLY TIGHTEN BOLTS.



# STEP 4

F		4 PCS
G		4 PCS
H		4 PCS
I		1 PC

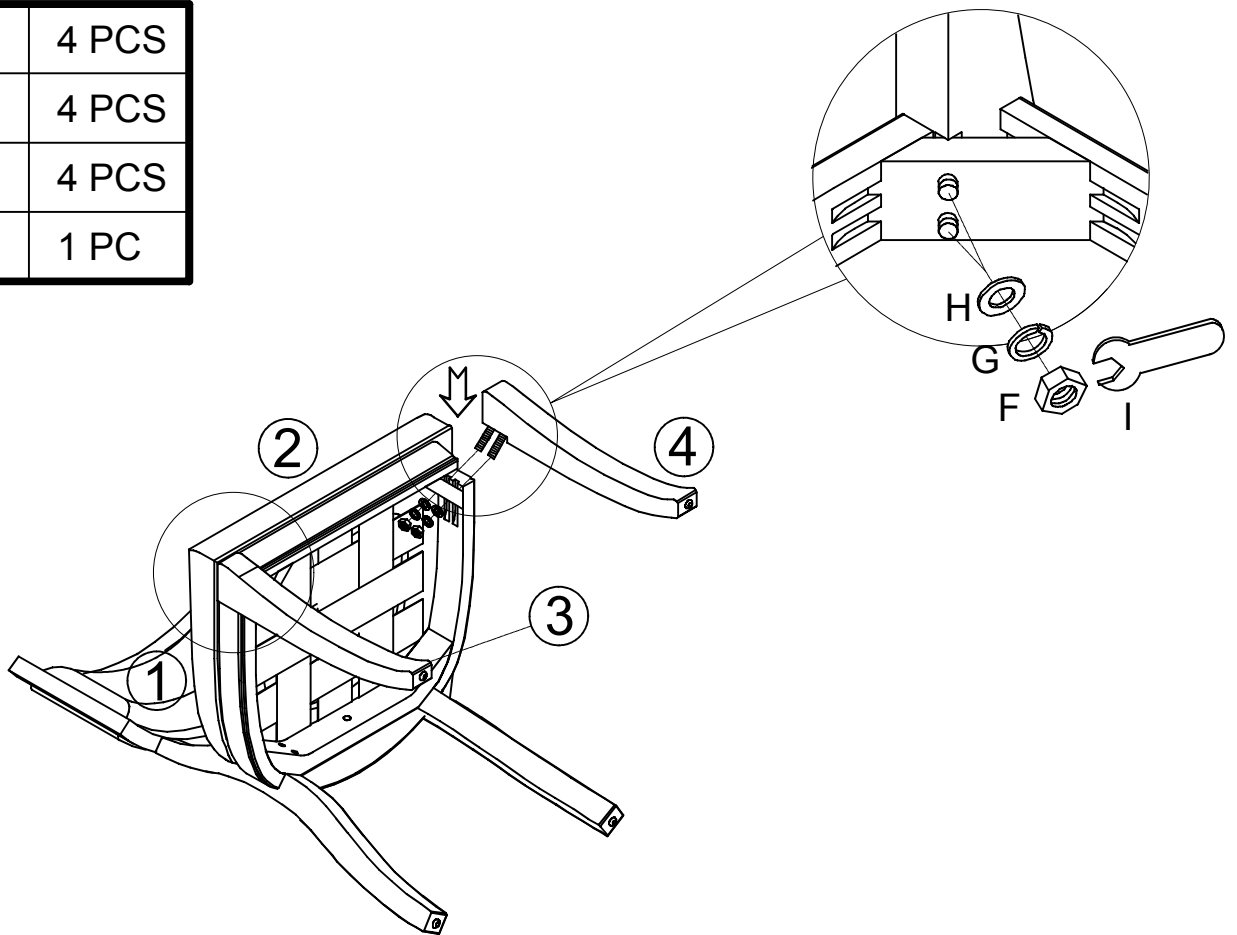

# STEP 5

MAKE SURE CHAIR IS LEVEL.  
THEN FULLY TIGHTEN ALL BOLTS.

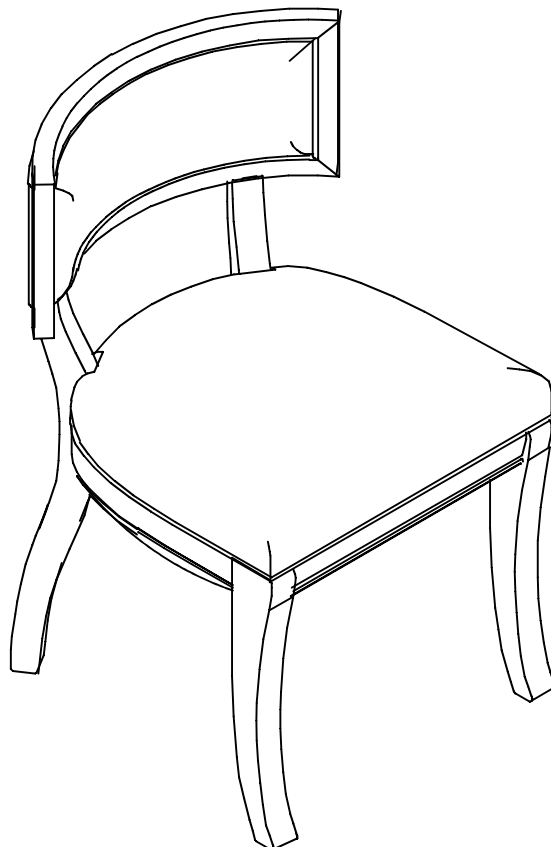

# Care & Maintenance

---

## Do...



Wipe up spills immediately.



Dust and pick-up spills using a clean, non-colored, lint-free, dry cloth.



Use mild non-abrasive soap and water.

---

## Don't...

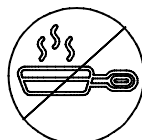

Do not put hot items directly on furniture surface.



Do not clean furniture with harsh cleansers or polish.

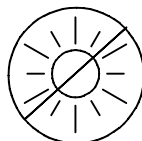

Do not place furniture in direct sunlight.



Do not place furniture near heating or cooling vents.

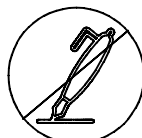

Do not write on furniture without a padded barrier to protect the surface.



Do not place furniture outside. For indoor use only.