



Important safety instructions:

- Please read carefully all instructions before assembly.
- For your safety and ease, assembly by two or more adults is recommended.
- Keep instructions for future use.

Pre-assembly:



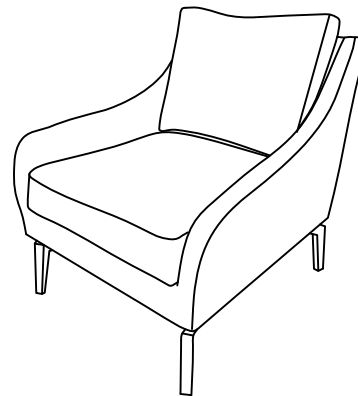

- Do not discard any content until assembly is complete to avoid accidentally discarding small parts or hardware.
- Take out all parts and hardware from box.

Parts List

Item	Description	QTY
P1	Chair Top 	1
P2	Metal Legs 	4
P3	Pillow 	1



Hardware List



Item	Description	QTY
H1	Bolts Ø5/16"*1" 	16
H2	Lock Washers 5/16" 	16
H3	Flat Washers 5/16" 	16
H4	Allen Wrench 5/16" 	1

DISCLAIMER:

WHEN PROPERLY ASSEMBLED, THIS ITEM IS SAFE FOR INTENDED USE. SELLER IS NOT LIABLE FOR ANY DAMAGES RESULTING FROM ITEM BEING IMPROPERLY ASSEMBLED AFTER PURCHASE.

Assembly Procedures:

Step 1: Assemble the chair on a flat, soft surface such as a carpet or cloth to prevent scratching the finish. Attach the metal legs (P2) to chair top (P1) as shown below.

- (H1)x16 Bolts Ø5/16"*1" 
- (H2)x16 Lock Washers 5/16" 
- (H3)x16 Flat Washers 5/16" 
- (H4)x1 Allen Wrench 5/16" 

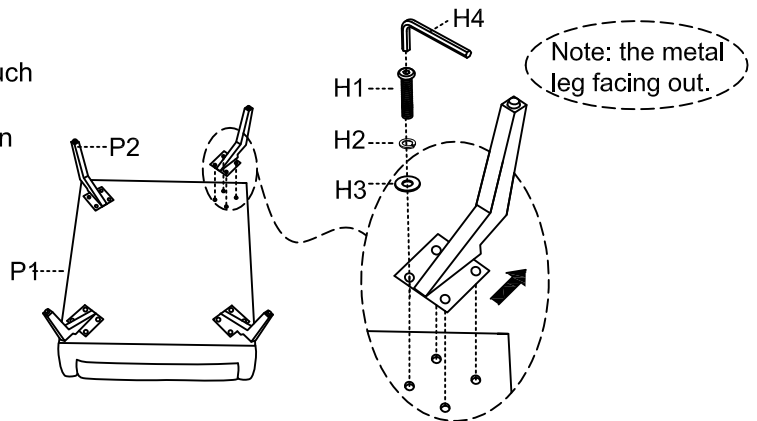

Step 2. Securely tighten all bolts, turn the assembled chair to an upright position, then put the pillow (P3) on the chair back as shown below. Assembly is complete. **Failure to follow these instructions may cause the bolts to misalign during assembly.**

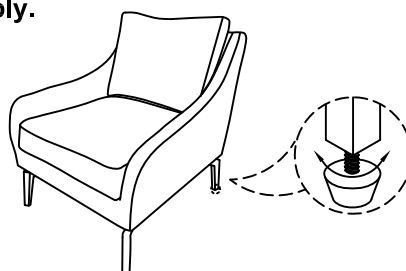

ADDITIONAL NOTE ABOUT SAFETY:

BOLTS MAY LOOSEN DURING NORMAL EVERYDAY USE.

THEY SHOULD BE INSPECTED AT LEAST EVERY 3 MONTHS AND RE-TIGHTENED AS NEEDED TO PREVENT DAMAGE OR INJURY, AND ENSURE STABILITY.

Thank you for your purchase