

ASSEMBLY INSTRUCTIONS

Description: Benson Wood Frame (non-teak)
Upholstered Dining Side Chair (Set of 2pcs)





Important safety instructions:

- Please read carefully all instructions before assembly.
- For your safety and ease, assembly by two or more adults is recommended.
- Keep instructions for future use.





Pre-assembly:

- Do not discard any content until assembly is complete to avoid accidentally discarding small parts or hardware.
- Take out all parts and hardware from box.

Parts List

Item	Description	QTY
P1	Right Leg Frame 	1
P2	Left Leg Frame 	1
P3	Seat Cushion 	1
P4	Back Cushion 	1

Hardware List



Item	Description	QTY
H1	Bolts Ø1/4"x45mm 	4
H2	Bolts Ø1/4"x75mm 	8
H3	Lock Washers Ø1/4" 	12
H4	Flat Washers Ø1/4"x19mm 	12
H5	Allen Key 4mm 	1

DISCLAIMER:

WHEN PROPERLY ASSEMBLED, THIS ITEM IS SAFE FOR INTENDED USE. SELLER IS NOT LIABLE FOR ANY DAMAGES RESULTING FROM ITEM BEING IMPROPERLY ASSEMBLED AFTER PURCHASE.

Assembly Procedures:

Step1: Assemble the dining chair on a flat, soft surface such as a carpet or cloth to prevent scratching the finish. Open the Velcro of back cushion (P4) to assemble. Attach Seat Cushion (P3), Back Cushion (P4) to Left Leg Frame (P2) as shown below. Don't Tighten all bolts.

- (H1)x2 Bolts Ø1/4"x45mm 
- (H2)x4 Bolts Ø1/4"x75mm 
- (H3)x6 Lock Washers Ø1/4" 
- (H4)x6 Flat Washers Ø1/4"x19mm 
- (H5)x1 Allen Key 4mm 

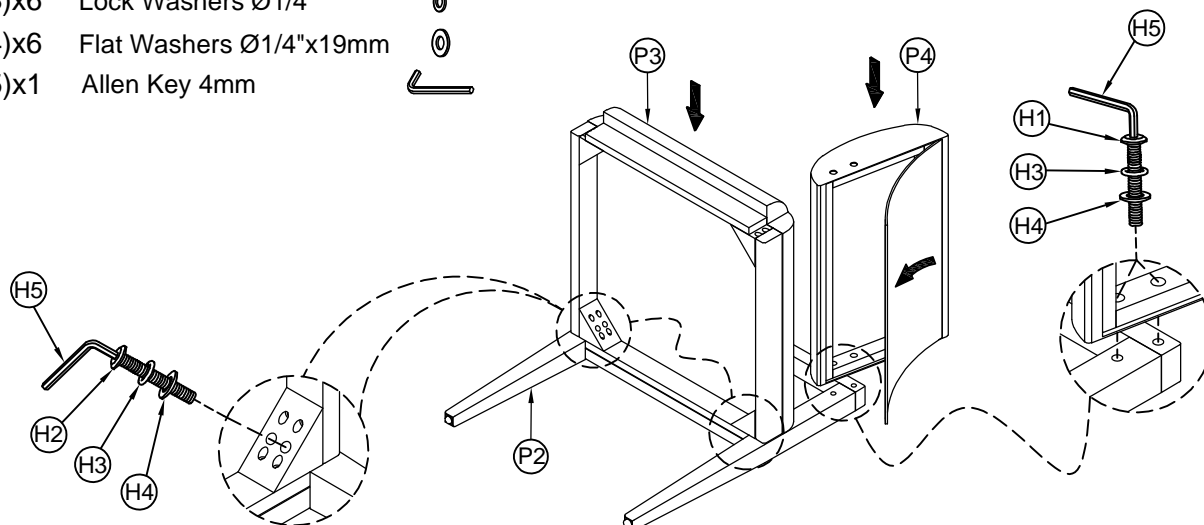

Step 2: Attach Right Leg Frame (P1) to Seat Cushion (P3) and Back Cushion (P4) as shown below. Tighten all bolts then close the Velcro of back cushion.

- (H1)x2 Bolts Ø1/4"x45mm 
- (H2)x4 Bolts Ø1/4"x75mm 
- (H3)x6 Lock Washers Ø1/4" 
- (H4)x6 Flat Washers Ø1/4"x19mm 
- (H5)x1 Allen Key 4mm 

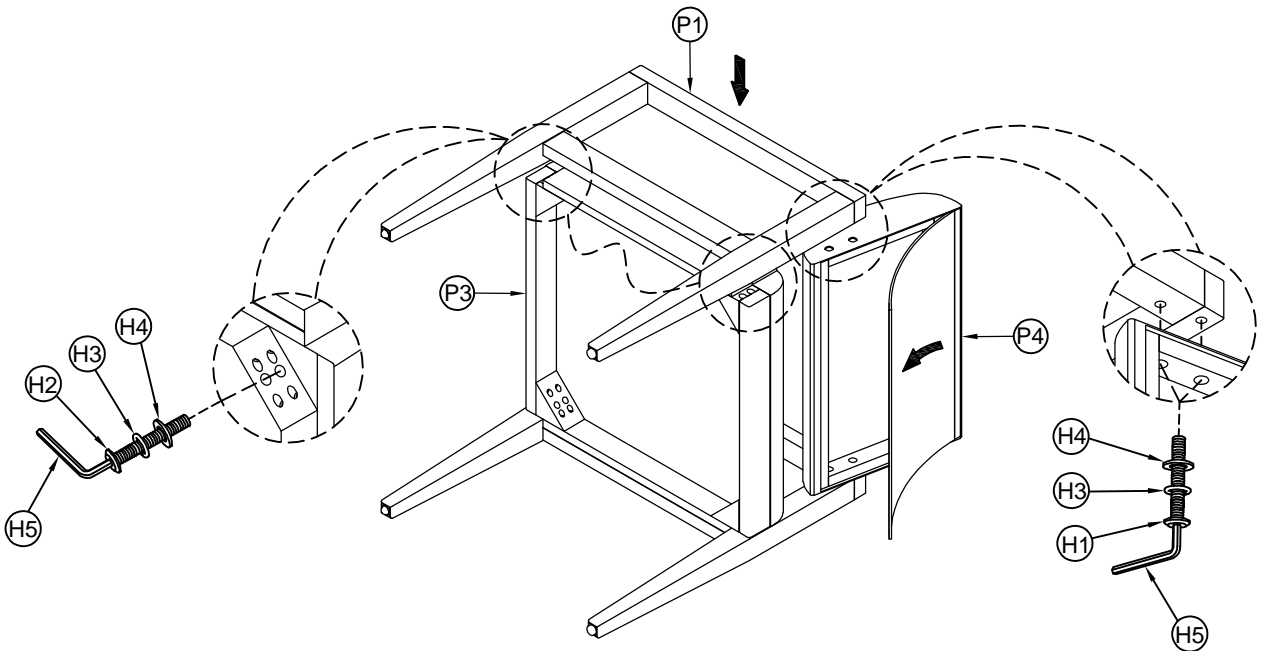

Step 3: Turn the assembled Chair to an upright position. Assembly is completed.
Repeat the assembling steps for the 2nd dining chair.

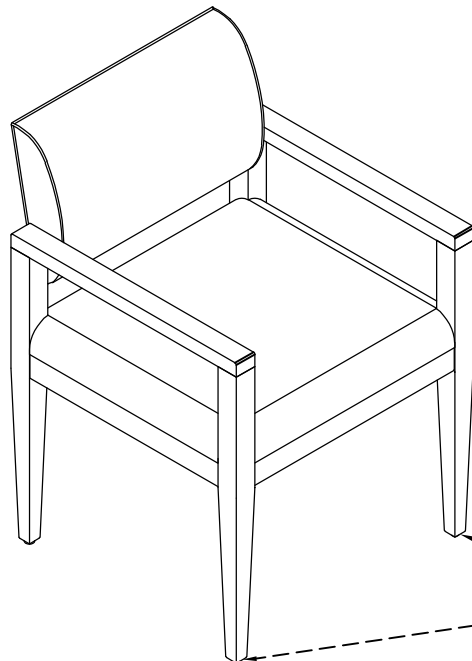

Note: Front Legs Can be Adjusted With Adjustable Levelers

ADDITIONAL NOTE ABOUT SAFETY:
BOLTS MAY LOOSEN DURING NORMAL EVERYDAY USE.
THEY SHOULD BE INSPECTED AT LEAST EVERY 3 MONTHS AND RE-TIGHTENED AS NEEDED TO PREVENT DAMAGE OR INJURY,
AND ENSURE STABILITY.

Thank you for your purchase