



# ASSEMBLY INSTRUCTIONS

Description: Malcom Accent Chair







### Important safety instructions:

- Please read carefully all instructions before assembly.
- For your safety and ease, assembly by two or more adults is recommended.
- Keep instructions for future use.



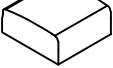

### Pre-assembly:

- Do not discard any content until assembly is complete to avoid accidentally discarding small parts or hardware.
- Take out all parts and hardware from box.

### Parts List

Item	Description	QTY
P1	LEFT ARM 	1
P2	RIGHT ARM 	1
P3	CHAIR BACK 	1
P4	CHAIR SEAT 	1
P5	FRONT LEGS 	2
P6	LEFT BACK LEG 	1
P7	RIGHT BACK LEG 	1

### Hardware List

Item	Description	QTY
H1	Bolts 5/16"x 1" 	12
H2	Bolts 5/16"x 1 1/2" 	13
H3	Lock Washers 5/16" 	25
H4	Flat Washers 5/16" 	25
H5	Allen Wrench 	1



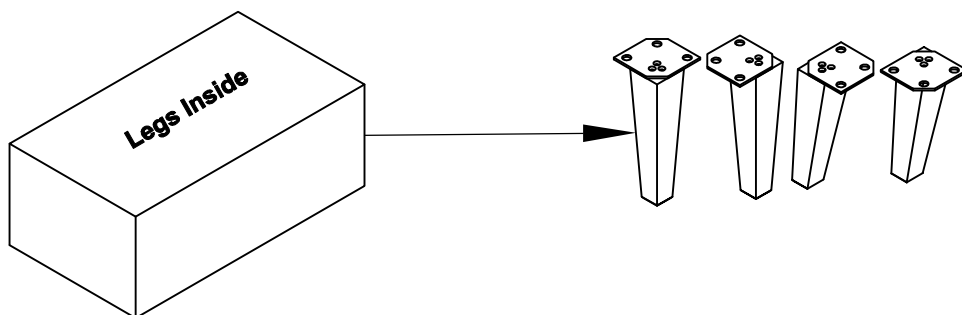

### DISCLAIMER:

**WHEN PROPERLY ASSEMBLED, THIS ITEM IS SAFE FOR INTENDED USE. SELLER IS NOT LIABLE FOR ANY DAMAGES RESULTING FROM ITEM BEING IMPROPERLY ASSEMBLED AFTER PURCHASE.**

**Step 1:** Assemble the Chair on a flat and soft surface either on a carpet or cloth to prevent the finish from scratching. Open Leg box then take out the Legs (P5), (P6), (P7).





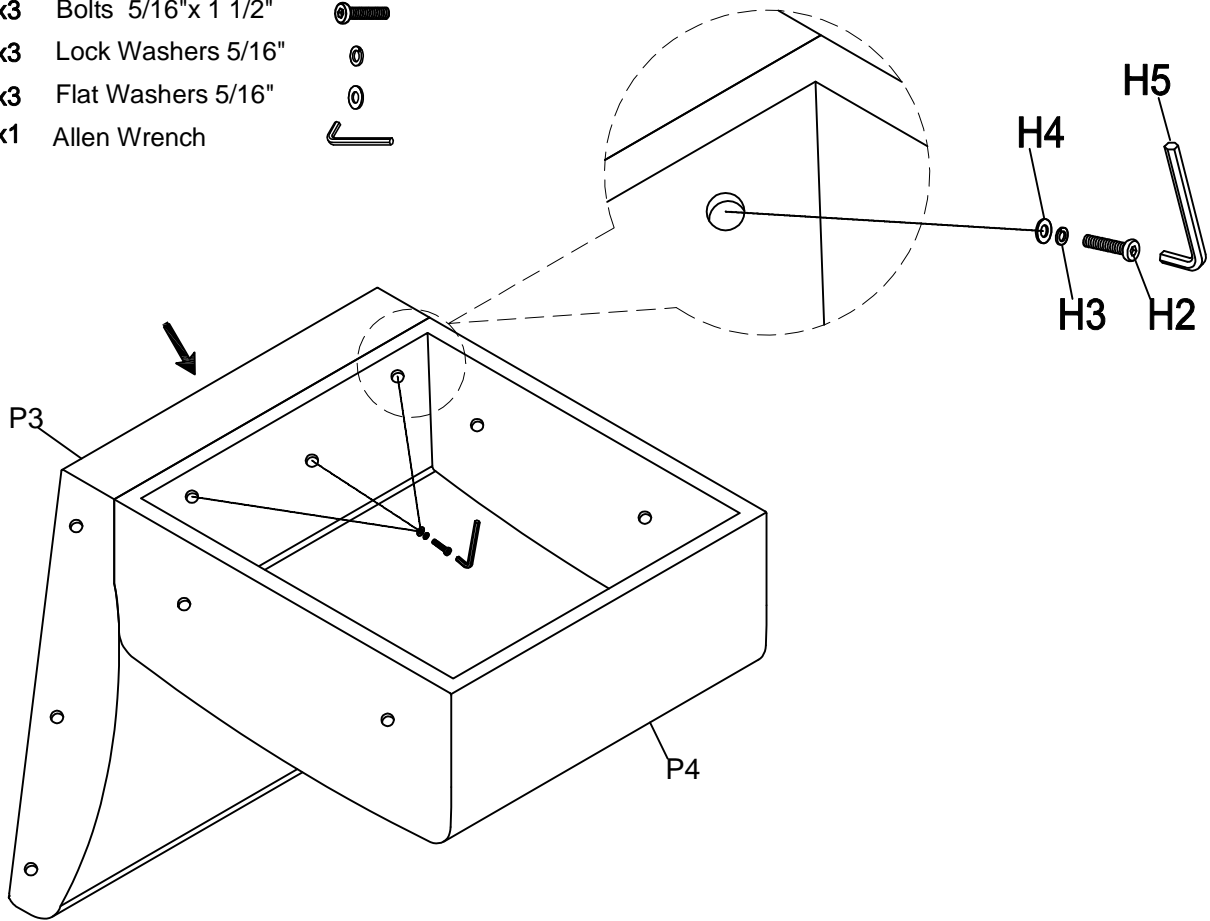

**Step 2:** Open velcro on Chair Seat and Chair Back. Attach Chair Seat (P4) to Chair Back (P3) as shown below:

- (H2)x3 Bolts 5/16"x 1 1/2" 
- (H3)x3 Lock Washers 5/16" 
- (H4)x3 Flat Washers 5/16" 
- (H5)x1 Allen Wrench 



**Step 3:** Attach Arm (P1), (P2) to frame assembled in Step 2 as shown below:

- (H2)x10 Bolts 5/16"x 1 1/2" 
- (H3)x10 Lock Washers 5/16" 
- (H4)x10 Flat Washers 5/16" 
- (H5)x1 Allen Wrench 

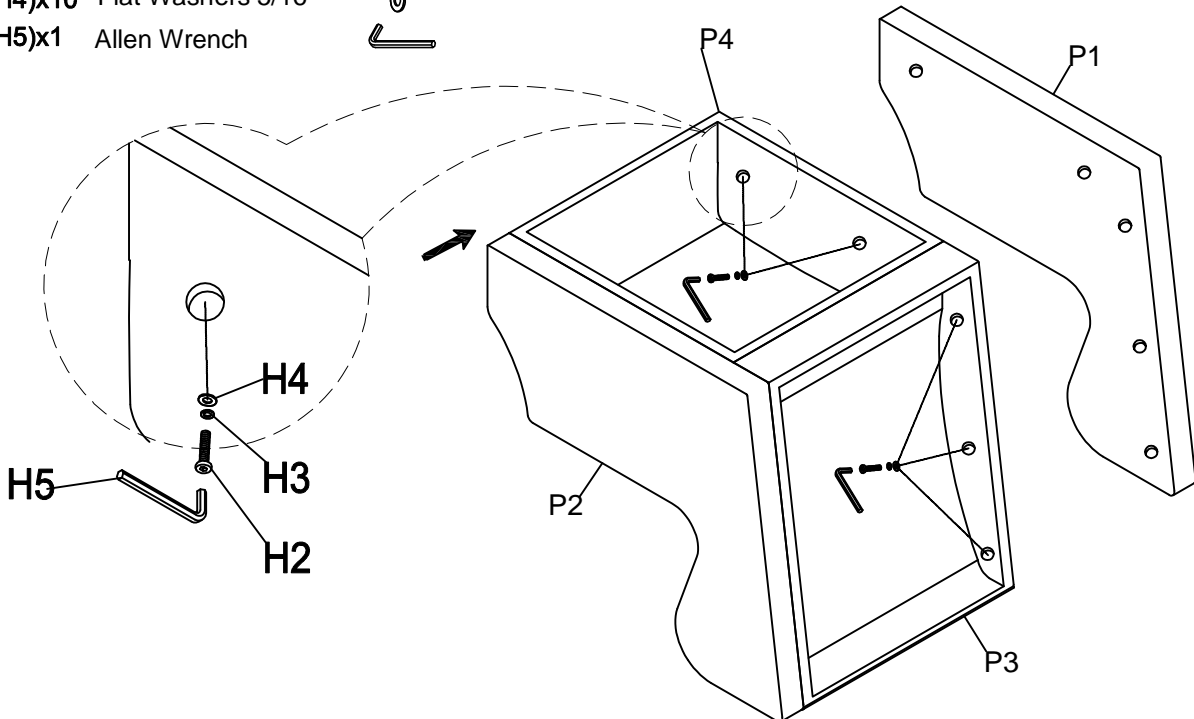

**Step 4: Attach Legs (P5), (P6), (P7) to frame assembled in Step 3 as shown below:**

(H1)x12 Bolts 5/16"x 1"

(H3)x12 Lock Washers 5/16"

(H4)x12 Flat Washers 5/16"

(H5)x1 Allen Wrench

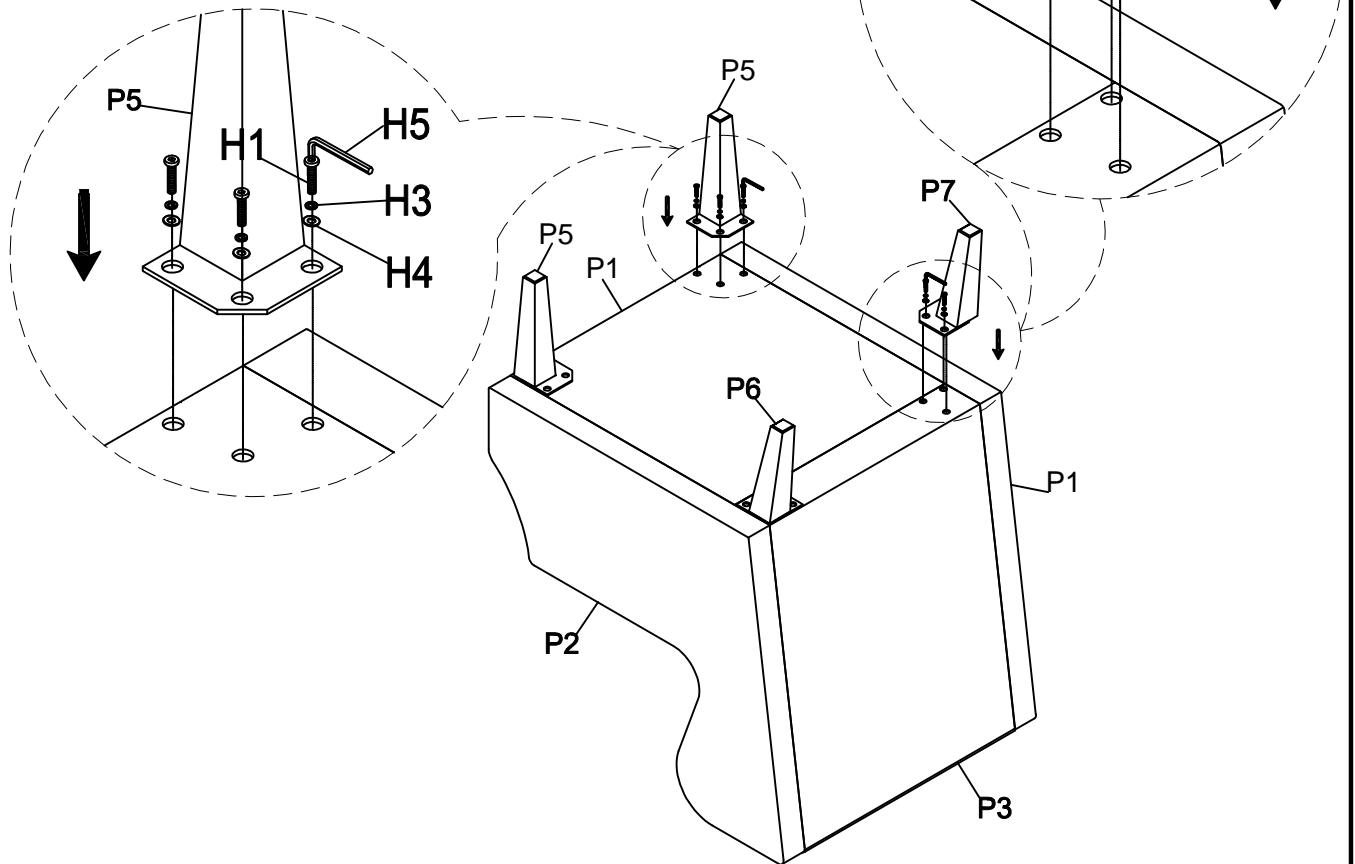

**Step 5: Turn the assembled chair to an upright position. Assembly is complete.**

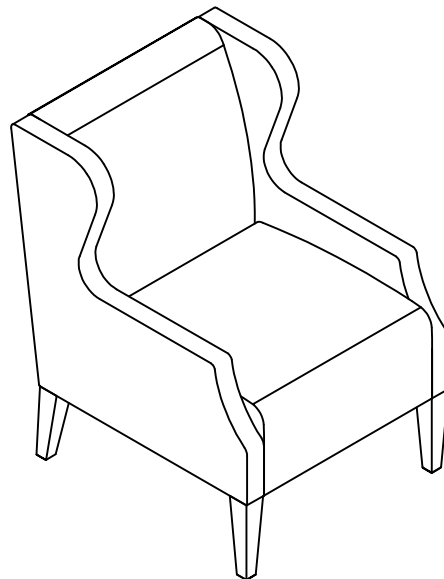

**ADDITIONAL NOTE ABOUT SAFETY: BOLTS MAY LOOSEN DURING NORMAL EVERYDAY USE. THEY SHOULD BE PERIODICALLY INSPECTED AND RE-TIGHTENED TO PREVENT DAMAGE OR INJURY. ALWAYS CHECK TO ENSURE THAT ALL HARDWARE IS KEPT TIGHTENED.**

Thank you for your purchase