

MADISON PARK® ASSEMBLY INSTRUCTIONS

Description: Delilah Accent Chair





Important safety instructions:

- Please read carefully all instructions before assembly.
- For your safety and ease, assembly by two or more adults is recommended.
- Keep instructions for future use.



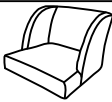

Pre-assembly:

- Do not discard any content until assembly is complete to avoid accidentally discarding small parts or hardware.
- Take out all parts and hardware from box.

Parts List

Item	Description	QTY
P1	Chair Body 	1
P2	Front Legs  (P2)	2
P3	Left Back Leg  (P3)	1
P4	Right Back Leg  (P4)	1

Hardware List

Item	Description	QTY
H1	Bolts Ø5/16"*2-1/4" 	8
H2	Lock Washers 5/16" 	8
H3	Flat Washers 5/16" 	8
H4	Allen Wrench 5/16" 	1

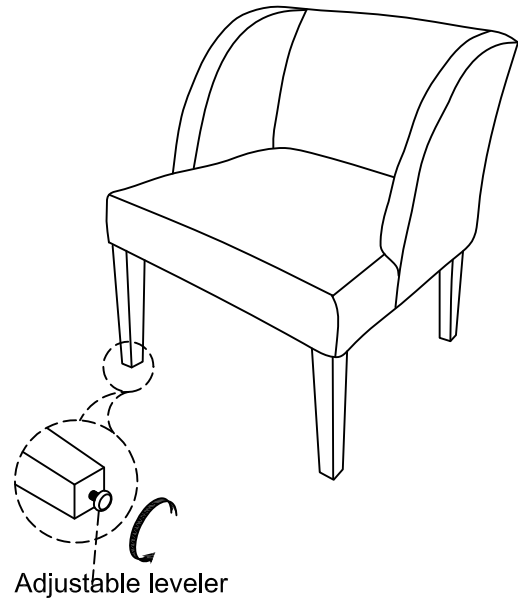





DISCLAIMER:

WHEN PROPERLY ASSEMBLED, THIS ITEM IS SAFE FOR INTENDED USE. SELLER IS NOT LIABLE FOR ANY DAMAGES RESULTING FROM ITEM BEING IMPROPERLY ASSEMBLED AFTER PURCHASE.

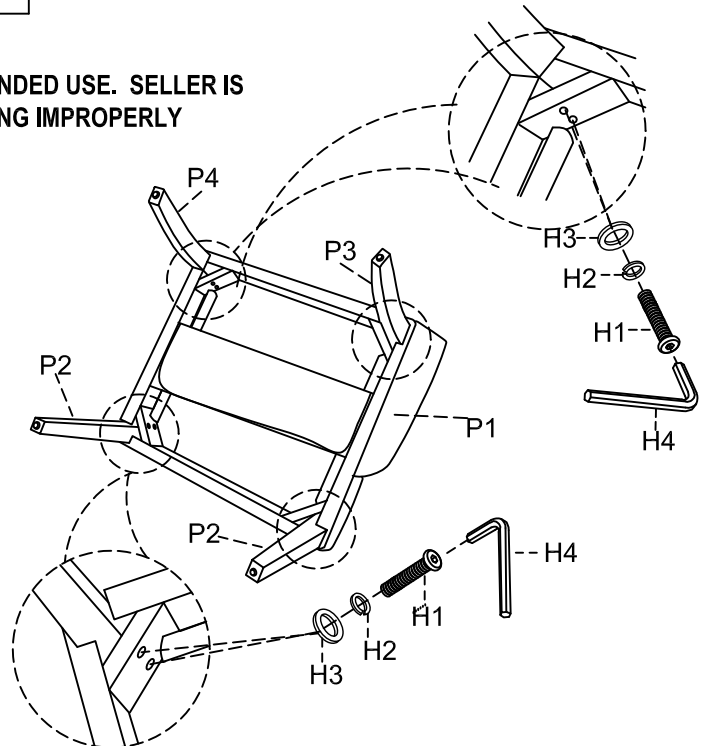
Assembly Procedures:

Step 1: Assemble the chair on a flat and soft surface either on a carpet or cloth to prevent the finish from scratching. To locate the hardware, please turn the chair upside down, you will find the components beneath the fabric cover that is secured by a Velcro strap underneath the seat cushion. Lift the strap upwards, legs and hardware box could be located beneath the fabric cover. Attach the front legs (P2) and left back leg (P3) and right back leg (P4) to the bottom of chair body (P1) as shown.



- (H1)x8 Bolts Ø5/16"*2-1/4" 
- (H2)x8 Lock Washers 5/16" 
- (H3)x8 Flat Washers 5/16" 
- (H4)x1 Allen Wrench 5/16" 

Step 2. Turn the assembled chair to an upright position. Make sure the chair is level and securely tighten all bolts with Allen wrench (H4).

Leveler adjustment: Leveler are pre-installed on the front legs and adjust as needed to make sure the chair is level. Assembly is complete. **Failure to follow these instructions may cause the bolts to misalign during assembly.**

ADDITIONAL NOTE ABOUT SAFETY:

BOLTS MAY LOOSEN DURING NORMAL EVERYDAY USE.

THEY SHOULD BE INSPECTED AT LEAST EVERY 3 MONTHS AND RE-TIGHTENED AS NEEDED TO PREVENT DAMAGE OR INJURY, AND ENSURE STABILITY.

Thank you for your purchase