

MADISON PARK® ASSEMBLY INSTRUCTIONS

Description: Grafton Accent chair





Important safety instructions:

- Please read carefully all instructions before assembly.
- For your safety and ease, assembly by two or more adults is recommended.
- Keep instructions for future use.





Pre-assembly:

- Do not discard any content until assembly is complete to avoid accidentally discarding small parts or hardware.
- Take out all parts and hardware from box.

Parts List

Item	Description	QTY
P1	Chair Back 	1
P2	Seat Cushion 	1
P3	Front Legs  (P3)	2
P4	Back Leg  (P4)	2

Hardware List

Item	Description	QTY
H1	Bolts Ø5/16"×2-1/2" 	14
H2	Lock Washers 5/16" 	14
H3	Flat Washers 5/16" 	14
H4	Allen Wrench 5/16" 	1

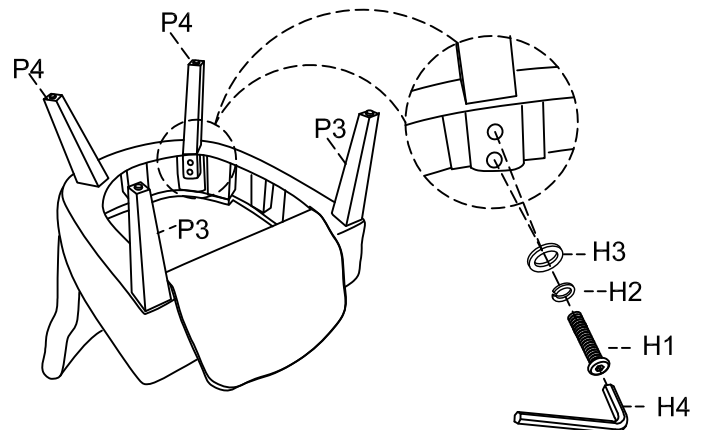
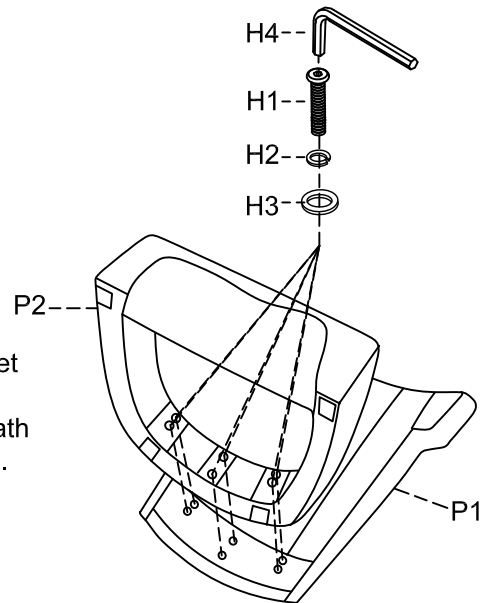
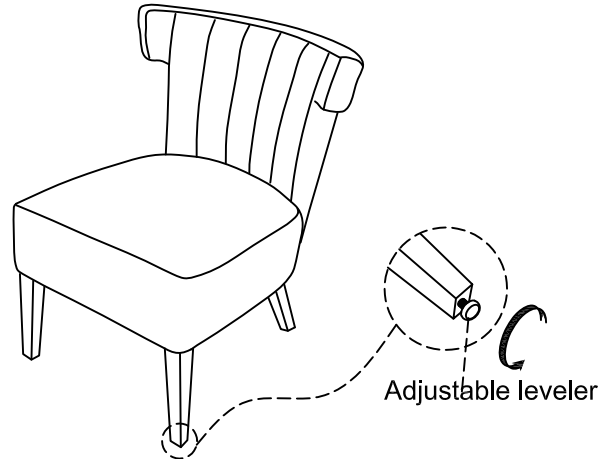



DISCLAIMER:

WHEN PROPERLY ASSEMBLED, THIS ITEM IS SAFE FOR INTENDED USE. SELLER IS NOT LIABLE FOR ANY DAMAGES RESULTING FROM ITEM BEING IMPROPERLY ASSEMBLED AFTER PURCHASE.

Assembly Procedures:

Step 1: Assemble the chair on a flat and soft surface either on a carpet or cloth to prevent the finish from scratching. To locate the hardware, please turn the chair upside down, you will find the components beneath the fabric cover that is secured by zipper underneath the seat cushion. Legs and hardware box could be located beneath the fabric cover. Attach the seat cushion (P2) to the chair back (P1) as shown.

- (H1)x14 Bolts Ø5/16"×2-1/2" 
- (H2)x14 Lock Washers 5/16" 
- (H3)x14 Flat Washers 5/16" 
- (H4)x1 Allen Wrench 5/16" 

Step 2. Attach the front legs (P3) and back legs(P4) to the bottom of seat cushion (P2) as shown. Turn the assembled chair to an upright position. Make sure the chair is level and securely tighten all bolts with Allen wrench (H4). **Leveler adjustment:** Levelers are pre-installed on the legs and adjust as needed to make sure the chair is leveled. Assembly is complete. **Failure to follow these instructions may cause the bolts to misalign during assembly.**

ADDITIONAL NOTE ABOUT SAFETY:

BOLTS MAY LOOSEN DURING NORMAL EVERYDAY USE. THEY SHOULD BE INSPECTED AT LEAST EVERY 3 MONTHS AND RE-TIGHTENED AS NEEDED TO PREVENT DAMAGE OR INJURY, AND ENSURE STABILITY.

Thank you for your purchase