



Important safety instructions:

- Please read carefully all instructions before assembly.
- For your safety and ease, assembly by two or more adults is recommended.
- Keep instructions for future use.







Pre-assembly:

- Do not discard any content until assembly is complete to avoid accidentally discarding small parts or hardware.
- Take out all parts and hardware from box.

Parts List

Item	Description	QTY
P1	Chair Back 	1
P2	Seat Cushion 	1
P3	Front Legs 	2

Hardware List

Item	Description	QTY
H1	Long Bolts $\phi 5/16'' \times 3-1/2''$ L 	4
H2	Medium Bolts $\phi 5/16'' \times 3''$ L 	4
H3	Short Bolt $\phi 5/16'' \times 1-3/4''$ L 	1
H4	Lock Washers $5/16''$ 	9
H5	Flat Washers $5/16''$ 	9
H6	Allen Wrench $5/16''$ 	1

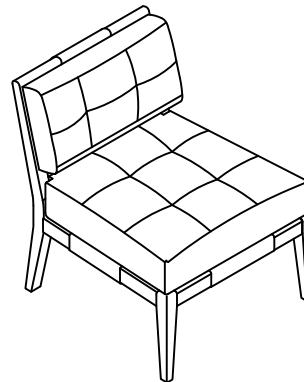





DISCLAIMER:

WHEN PROPERLY ASSEMBLED, THIS ITEM IS SAFE FOR INTENDED USE. SELLER IS NOT LIABLE FOR ANY DAMAGES RESULTING FROM ITEM BEING IMPROPERLY ASSEMBLED AFTER PURCHASE.

Assembly Procedures:

Step 1: Assemble the chair on a flat, soft surface such as a carpet or cloth to prevent scratching the finish. Attach the seat cushion (P2) to the chair back (P1) as shown below.



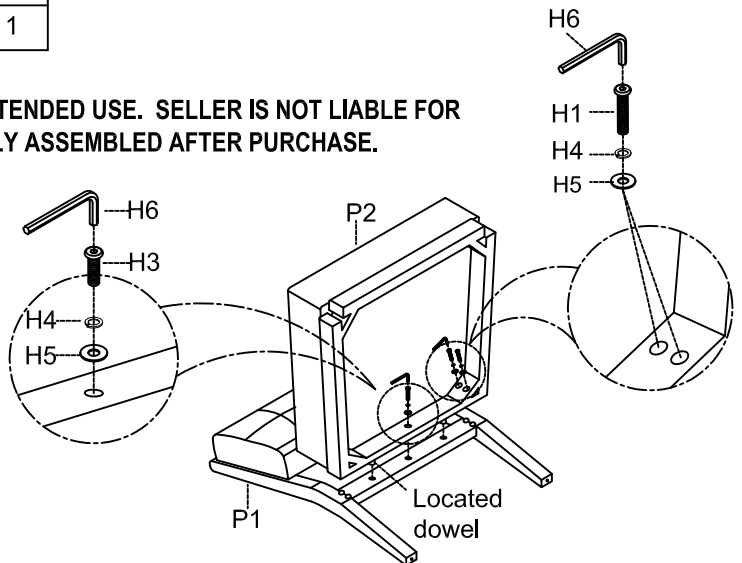

- (H1)x4 Long Bolts $\phi 5/16'' \times 3''$ L 
- (H3)x1 Short Bolts $\phi 5/16'' \times 1-3/4''$ L 
- (H4)x5 Lock Washers $5/16''$ 
- (H5)x5 Flat Washers $5/16''$ 
- (H6)x1 Allen Wrench $5/16''$ 



Step 2.

a. Attach the front legs (P3) to the bottom of seat cushion (P2) as shown below.

b. Securely tighten all bolts, turn the assembled chair to an upright position, Assembly is complete. **Failure to follow these instructions may cause the bolts to misalign during assembly.**

- (H2)x4 Medium Bolts $\phi 5/16'' \times 3''$ L 
- (H4)x4 Lock Washers $5/16''$ 
- (H5)x4 Flat Washers $5/16''$ 
- (H6)x1 Allen Wrench $5/16''$ 

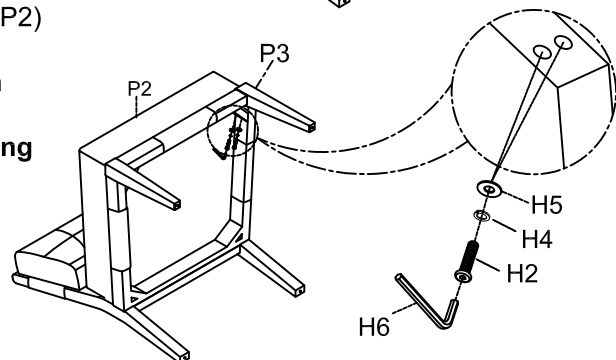

ADDITIONAL NOTE ABOUT SAFETY:

BOLTS MAY LOOSEN DURING NORMAL EVERYDAY USE.

THEY SHOULD BE INSPECTED AT LEAST EVERY 3 MONTHS AND RE-TIGHTENED AS NEEDED TO PREVENT DAMAGE OR INJURY, AND ENSURE STABILITY.

Thank you for your purchase