



**Important safety instructions:**

- Please read carefully all instructions before assembly.
- For your safety and ease, assembly by two or more adults is recommended.
- Keep instructions for future use.



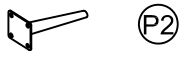

**Pre-assembly:**

- Do not discard any content until assembly is complete to avoid accidentally discarding small parts or hardware.
- Take out all parts and hardware from box.

**Parts List**

Item	Description	QTY
P1	Chair Top 	1
P2	Front Legs 	2
P3	Back Legs 	2

**Hardware List**

Item	Description	QTY
H1	Bolts $\varnothing 1/4" \times 3/4"$ 	16
H2	Lock Washers $\varnothing 1/4"$ 	16
H3	Flat Washers $\varnothing 1/4" \times 19\text{mm}$ 	16
H4	Allen Wrench $1/4"$ 	1

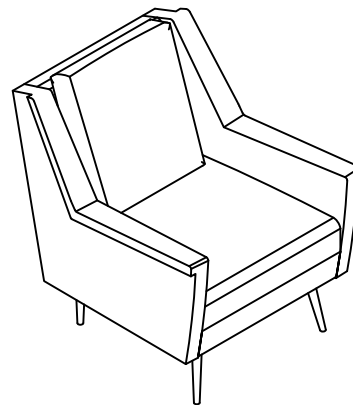



**DISCLAIMER:**

WHEN PROPERLY ASSEMBLED, THIS ITEM IS SAFE FOR INTENDED USE. SELLER IS NOT LIABLE FOR ANY DAMAGES RESULTING FROM ITEM BEING IMPROPERLY ASSEMBLED AFTER PURCHASE.

**Assembly Procedures:**

Step 1: Assemble the chair on a flat, soft surface such as a carpet or cloth to prevent scratching the finish. Attach the front legs (P2) and back legs (P3) to the chair top (P1) as shown below.

- (H1)x16 Bolts  $\varnothing 1/4" \times 3/4"$  
- (H2)x16 Lock Washers  $\varnothing 1/4"$  
- (H3)x16 Flat Washers  $\varnothing 1/4" \times 19\text{mm}$  
- (H4)x1 Allen Wrench  $1/4"$  

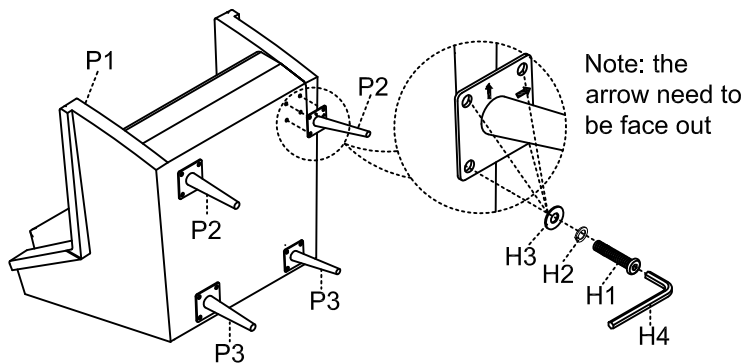

Step 2. Securely tighten all bolts, turn the assembled chair to an upright position. Assembly is complete. **Failure to follow these instructions may cause the bolts to misalign during assembly.**

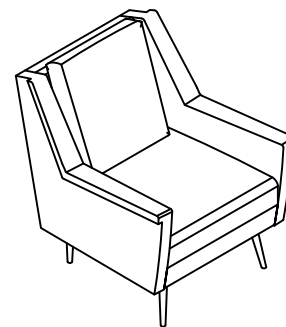

**ADDITIONAL NOTE ABOUT SAFETY:**

**BOLTS MAY LOOSEN DURING NORMAL EVERYDAY USE.**

**THEY SHOULD BE INSPECTED AT LEAST EVERY 3 MONTHS AND RE-TIGHTENED AS NEEDED TO PREVENT DAMAGE OR INJURY, AND ENSURE STABILITY.**

Thank you for your purchase