



Important safety instructions:

- Please read carefully all instructions before assembly.
- For your safety and ease, assembly by two or more adults is recommended.
- Keep instructions for future use.





Pre-assembly:

- Do not discard any content until assembly is complete to avoid accidentally discarding small parts or hardware.
- Take out all parts and hardware from box.

Parts List

Item	Description		QTY
P1	CHAIR		1
P2	FRONT LEGS		2
P3	BACK LEGS		2

Hardware List

Item	Description		QTY
H1	Bolts 5/16"x 51mm		8
H2	Lock Washers 5/16"		8
H3	Flat Washers 5/16"		8
H4	Allen Wrench		1

DISCLAIMER:



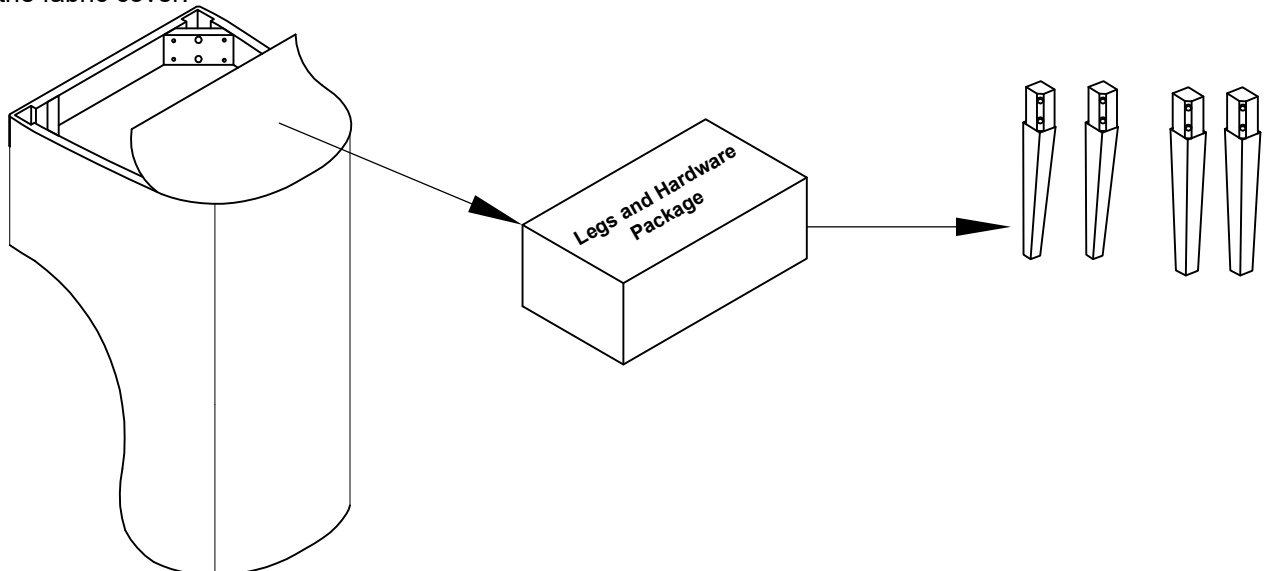

WHEN PROPERLY ASSEMBLED, THIS ITEM IS SAFE FOR INTENDED USE. SELLER IS NOT LIABLE FOR ANY DAMAGES RESULTING FROM ITEM BEING IMPROPERLY ASSEMBLED AFTER PURCHASE.

Assembly Procedures:

Step 1: Assemble the chair on a flat and soft surface either on a carpet or cloth to prevent the finish from scratching. To locate the hardware, please turn the chair upside down, you will find the components beneath the fabric cover that is secured by a Velcro strap underneath the seat cushion. Lift the strap upwards, legs and hardware box could be located beneath the fabric cover.



Step 2: Attach the Legs (P2), (P3) to the Chair (P1) as shown below.

- (H1)x8 Bolts 5/16"x 51mm 
- (H2)x8 Lock Washers 5/16" 
- (H3)x8 Flat Washers 5/16" 
- (H4)x1 Allen Wrench 

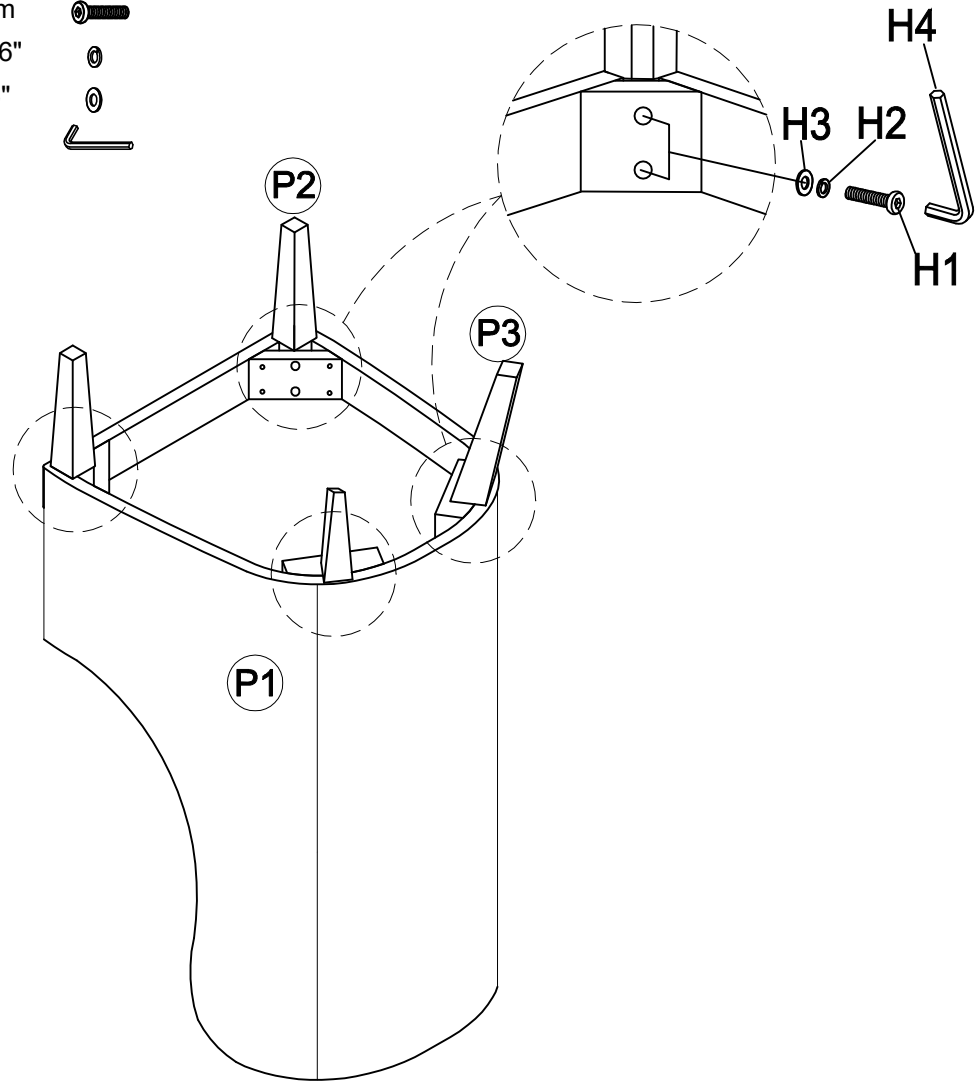

Step 3: Turn the chair over and place it upright on a level surface.
Assembly is complete.

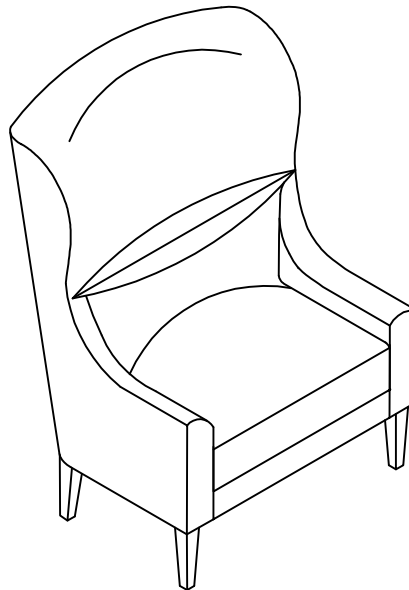

ADDITIONAL NOTE ABOUT SAFETY: BOLTS MAY LOOSEN DURING NORMAL EVERYDAY USE. THEY SHOULD BE PERIODICALLY INSPECTED AND RE-TIGHTENED TO PREVENT DAMAGE OR INJURY. ALWAYS CHECK TO ENSURE THAT ALL HARDWARE IS KEPT TIGHTENED.

Thank you for your purchase