

# MADISONPARK® ASSEMBLY INSTRUCTIONS

## Description: Angelica Arm Dining Chair



### Important safety instructions:

- Please read carefully all instructions before assembly.
- For your safety and ease, assembly by two or more adults is recommended.
- Keep instructions for future use.





### Pre-assembly:

- Do not discard any content until assembly is complete to avoid accidentally discarding small parts or hardware.
- Take out all parts and hardware from box.

### Parts List

Item	Description	QTY
P1	Chair Top 	1
P2	Front Legs 	2
P3	Back Legs 	2

### Hardware List

Item	Description	QTY
H1	Bolts Ø5/16"*2" 	8
H2	Lock Washers 5/16" 	8
H3	Flat Washers 5/16" 	8
H4	Allen Wrench 5/16" 	1

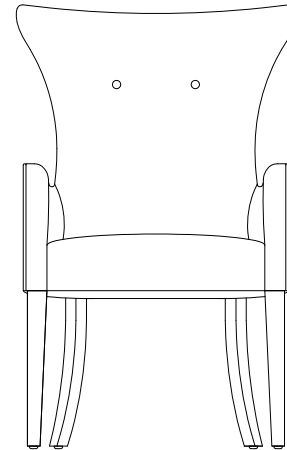

### DISCLAIMER:

WHEN PROPERLY ASSEMBLED, THIS ITEM IS SAFE FOR INTENDED USE. SELLER IS NOT LIABLE FOR ANY DAMAGES RESULTING FROM ITEM BEING IMPROPERLY ASSEMBLED AFTER PURCHASE.

### Assembly Procedures:

Step 1. Assemble the chair on a flat, soft surface such as a carpet or cloth to prevent scratching the finish.

1) Loosely attach the front/back legs (P2, P3) to the chair top (P1) using bolts (H1), lock washers (H2) and flat washers (H3) as shown below.

2) Turn the assembled chair to an upright position. Make sure the chair is level and securely tighten all bolts with Allen wrench (H4). Assembly is complete. **Failure to follow these instructions may cause the bolts to misalign during assembly.**

(H1)x8 Bolts Ø5/16"\*2" 

(H2)x8 Lock Washers Ø5/16" 

(H3)x8 Flat Washers Ø5/16" 

(H4)x1 Allen Wrench 5/16" 

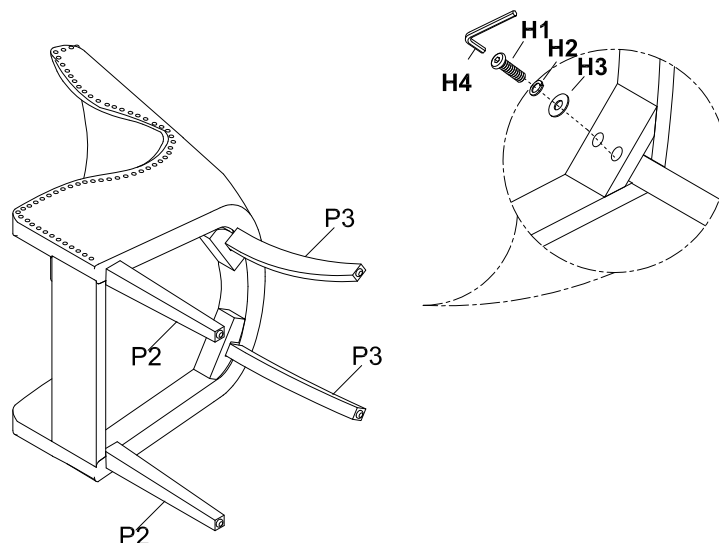

**ADDITIONAL NOTE ABOUT SAFETY: BOLTS MAY LOOSEN DURING NORMAL EVERYDAY USE. THEY SHOULD BE PERIODICALLY INSPECTED AND RE-TIGHTENED TO PREVENT DAMAGE OR INJURY. ALWAYS CHECK TO ENSURE THAT ALL HARDWARE IS KEPT TIGHTENED.**

Thank you for your purchase