





**Important safety instructions:**

- Please read carefully all instructions before assembly.
- For your safety and ease, assembly by two or more adults is recommended.
- Keep instructions for future use.









**Pre-assembly:**

- Do not discard any content until assembly is complete to avoid accidentally discarding small parts or hardware.
- Take out all parts and hardware from box.

**Parts List**

Item	Description	QTY
P1	Chair Back 	1
P2	Left Arm 	1
P3	Right Arm 	1
P4	Seat Frame with Panel 	1
P5	Seat Cushion 	1

**Hardware List**

Item	Description	QTY
H1	Big Bolts $\phi 5/16"$ x 1-3/4"L 	6
H2	Big Lock Washers 5/16" 	6
H3	Big Flat Washers 5/16" 	6
H4	Big Allen Wrench 5/16" 	1
H5	Small Bolts $\phi 1/4"$ x 1-3/4"L 	4
H6	Small Lock Washers 1/4" 	4
H7	Small Flat Washers 1/4" 	4
H8	Small Allen Wrench 1/4" 	1
H9	Wooden Plugs 	4

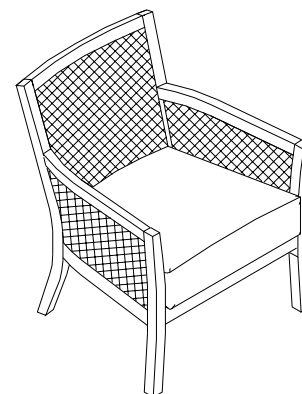

**DISCLAIMER:**

WHEN PROPERLY ASSEMBLED, THIS ITEM IS SAFE FOR INTENDED USE. SELLER IS NOT LIABLE FOR ANY DAMAGES RESULTING FROM ITEM BEING IMPROPERLY ASSEMBLED AFTER PURCHASE.



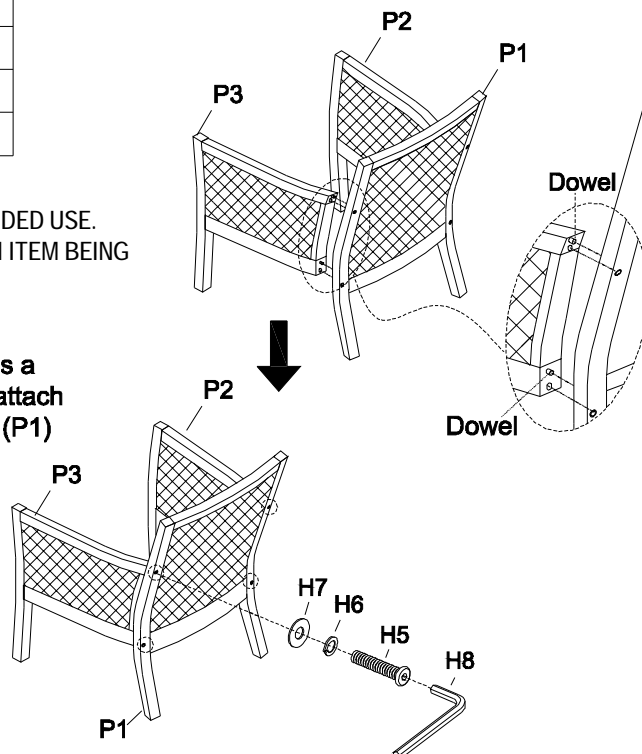

**Assembly Procedures:**

**Step 1: Assemble the chair on a flat, soft surface such as a carpet or cloth to prevent scratching the finish. Loosely attach the left arm (P2) and the right arm (P3) to the chair back (P1) as shown below.**

- (H5)x4 Small Bolts  $\phi 1/4"$ x 1-3/4"L 
- (H6)x4 Small Lock Washers 1/4" 
- (H7)x4 Small Flat Washers 1/4" 
- (H8)x1 Small Allen Wrench 1/4" 



**Step 2. Loosely attach the seat frame with panel (P4) to the left arm (P2), the right arm (P3) and the chair back (P1) as shown below.**

- (H1)x6 Big Bolts  $\text{Ø}5/16 \times 1-3/4 \text{ L}$  
- (H2)x6 Big Lock Washers  $\text{Ø}5/16$  
- (H3)x6 Big Flat Washers  $\text{Ø}5/16$  
- (H4)x1 Big Allen Wrench  $\text{Ø}5/16$  

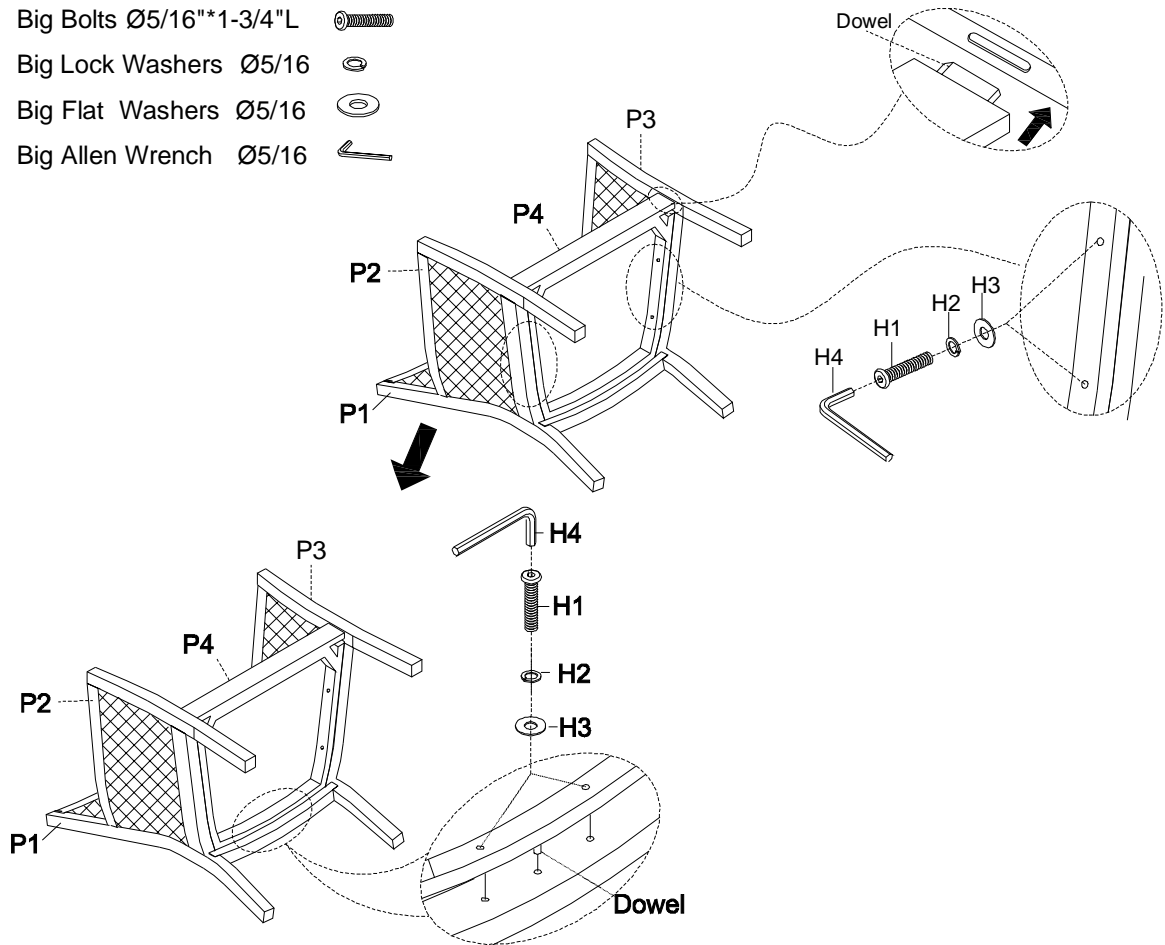

**Step 3.**

- a. Securely tighten all bolts with Allen wrench(H4 & H8), turn the assembled chair to an upright position, make sure the chair is level, aligned properly.
- b. Put the seat cushion (P5) on the seat frame with panel (P4).
- c. Attach wooden plugs (H9) to each exposed bolt holes, tighten with rubber hammer to knock the wooden plug till its tighten. **Note:** use a soft cloth between the wooden plug and hammer to prevent damage to wooden plug finish.
- d. Assembly is complete. **Failure to follow these instructions may cause the bolts to misalign during assembly.**

- (H9)x4 Wooden Plugs 

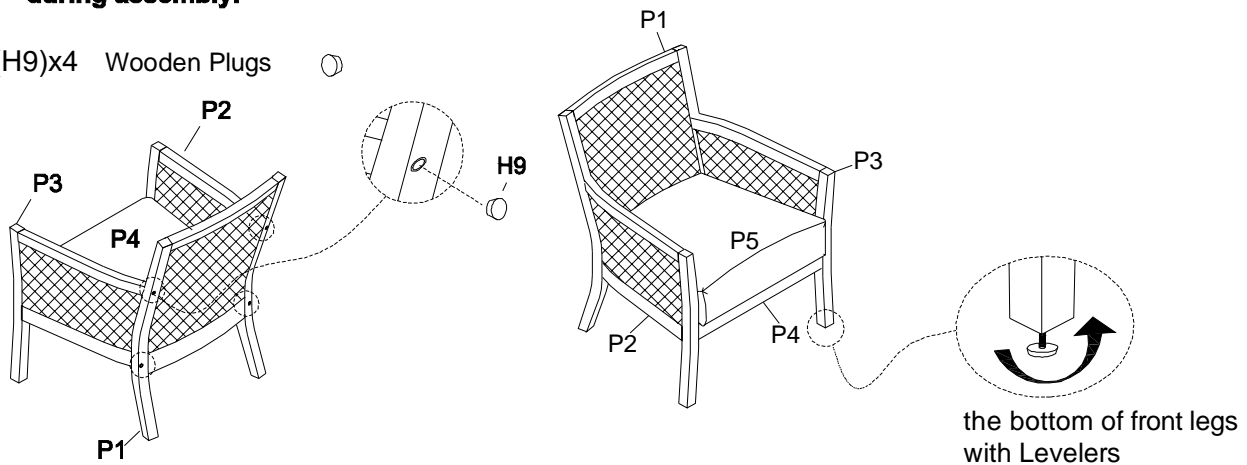

ADDITIONAL NOTE ABOUT SAFETY: BOLTS MAY LOOSEN DURING NORMAL EVERYDAY USE. THEY SHOULD BE PERIODICALLY INSPECTED AND RE-TIGHTENED TO PREVENT DAMAGE OR INJURY. ALWAYS CHECK TO ENSURE THAT ALL HARDWARE IS KEPT TIGHTENED.

**Thank you for your purchase**