

ASSEMBLY INSTRUCTIONS

Description: Lacey Accent Chair





Important safety instructions:

- Please read carefully all instructions before assembly.
- For your safety and ease, assembly by two or more adults is recommended.
- Keep instructions for future use.





Pre-assembly:

- Do not discard any content until assembly is complete to avoid accidentally discarding small parts or hardware.
- Take out all parts and hardware from box.

Parts List

Item	Description	QTY
P1	Chair Back 	1
P2	Chair Seat  (P2)	1
P3	Front Legs  (P3)	2
P4	Back Legs  (P4)	2

Hardware List

Item	Description	QTY
H1	Bolts Ø5/16"*2-1/4" 	13
H2	Lock Washers Ø5/16" 	13
H3	Flat Washers Ø5/16" 	13
H4	Allen Wrench 5/16" 	1

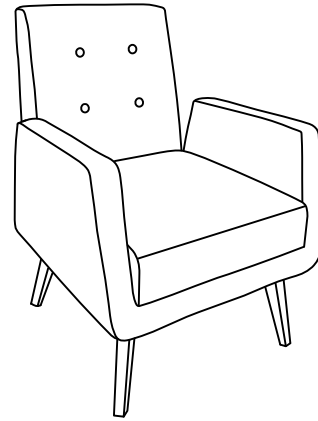





DISCLAIMER:

WHEN PROPERLY ASSEMBLED, THIS ITEM IS SAFE FOR INTENDED USE. SELLER IS NOT LIABLE FOR ANY DAMAGES RESULTING FROM ITEM BEING IMPROPERLY ASSEMBLED AFTER PURCHASE.

Assembly Procedures:

Step 1: Assemble the chair on a flat and soft surface either on a carpet or cloth to prevent the finish from scratching. Attach the chair seat (P2) to the chair back (P1) as shown.

Step 2: Attach the front legs (P3) and back legs (P4) to the bottom of chair body (P2) as shown.

- (H1)x13 Bolts Ø5/16"*2-1/4" 
- (H2)x13 Lock Washers Ø5/16" 
- (H3)x13 Flat Washers Ø5/16" 
- (H4)x1 Allen Wrench 5/16" 

Step 3. Turn the assembled chair to an upright position. Make sure the chair is level and securely tighten all bolts with Allen wrench (H4). Assembly is complete. **Failure to follow these instructions may cause the bolts to misalign during assembly.**

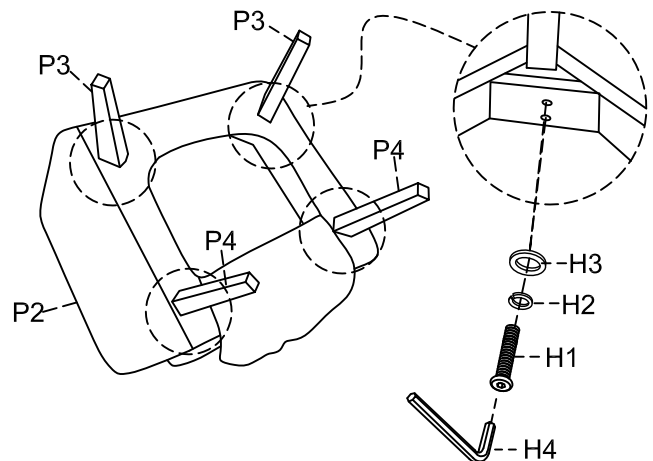
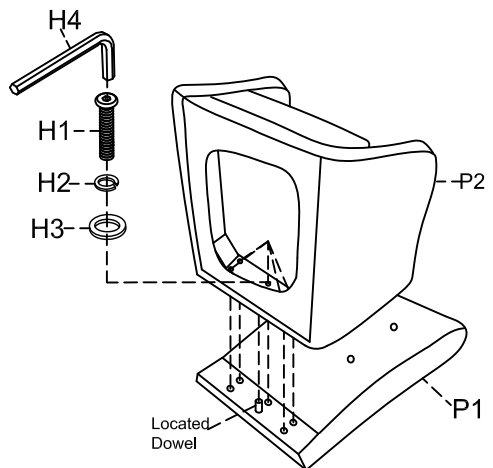

ADDITIONAL NOTE ABOUT SAFETY: BOLTS MAY LOOSEN DURING NORMAL EVERYDAY USE. THEY SHOULD BE PERIODICALLY INSPECTED AND RE-TIGHTENED TO PREVENT DAMAGE OR INJURY. ALWAYS CHECK TO ENSURE THAT ALL HARDWARE IS KEPT TIGHTENED.

Thank you for your purchase