



Important safety instructions:

- Please read carefully all instructions before assembly.
- For your safety and ease, assembly by two or more adults is recommended.
- Keep instructions for future use.

Pre-assembly:



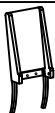

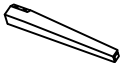
- Do not discard any content until assembly is complete to avoid accidentally discarding small parts or hardware.
- Take out all parts and hardware from box.

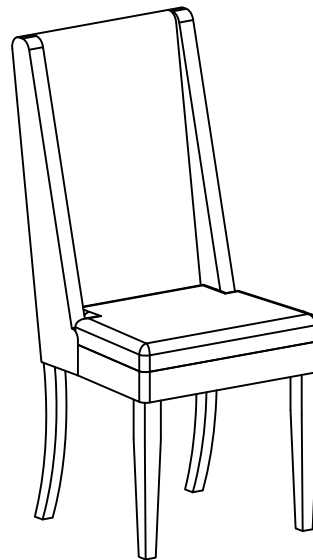
Parts List

Item	Description	QTY
P1	Chair Back 	1
P2	Seat Cushion 	1
P3	Front Legs 	2



Hardware List





Item	Description	QTY
H1	Short Bolts Ø5/16**2" 	4
H2	Long Bolts Ø5/16**2-1/4" 	4
H3	Lock Washers Ø5/16" 	8
H4	Flat Washers Ø5/16" 	8
H5	Allen Wrench 5/16" 	1

DISCLAIMER:

WHEN PROPERLY ASSEMBLED, THIS ITEM IS SAFE FOR INTENDED USE. SELLER IS NOT LIABLE FOR ANY DAMAGES RESULTING FROM ITEM BEING IMPROPERLY ASSEMBLED AFTER PURCHASE.



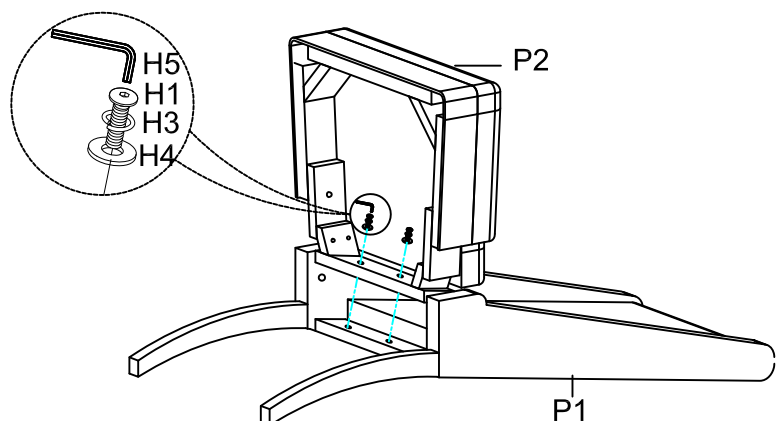

Assembly Procedures:

Step 1. Assemble the chair on a flat, soft surface such as a carpet or cloth to prevent scratching the finish. Attach the seat cushion (P2) to chair back (P1) using bolts (H1), lock washers (H3), flat washers (H4). Loosely tighten by Allen wrench (H5).

- (H1)x2 Short Bolts Ø5/16**2" 
- (H3)x2 Lock Washers Ø5/16" 
- (H4)x2 Flat Washers Ø5/16" 
- (H5)x1 Allen Wrench 5/16" 



Step 2. Attach the seat cushion (P2) to the leg of chair back (P1) using bolts (H1), lock washers (H3) and flat washers (H4). Loosely tighten with Allen wrench (H5).

- (H1)x2 Short Bolts $\text{Ø}5/16'' \times 2''$ 
- (H3)x2 Lock Washers $\text{Ø}5/16''$ 
- (H4)x2 Flat Washers $\text{Ø}5/16''$ 
- (H5)x1 Allen Wrench $5/16''$ 

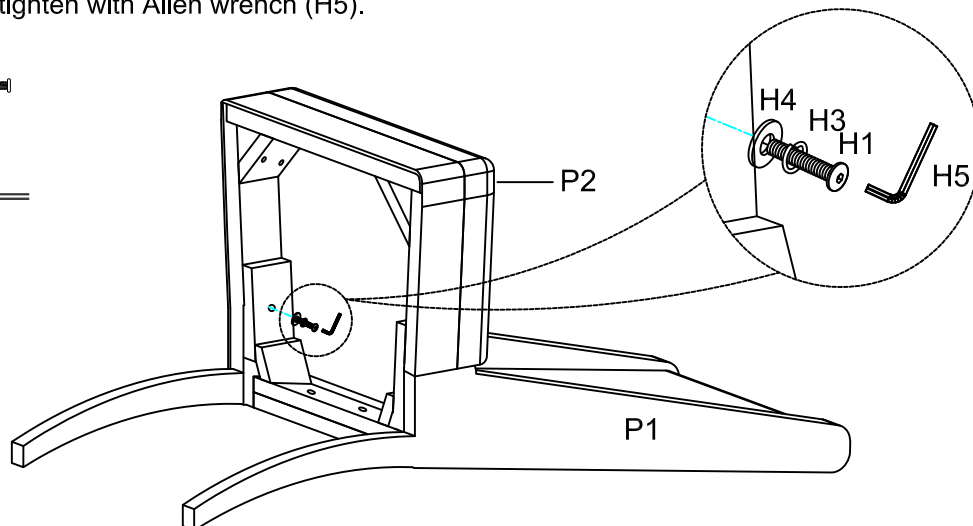

Step 3. Attach front legs (P3) to seat cushion (P2) using bolts (H2), lock washers (H3) and flat washers (H4). Loosely tighten the bolts with Allen wrench (H5).

- (H2)x4 Long Bolts $\text{Ø}5/16'' \times 2-1/4''$ 
- (H3)x4 Lock Washers $\text{Ø}5/16''$ 
- (H4)x4 Flat Washers $\text{Ø}5/16''$ 
- (H5)x1 Allen Wrench $5/16''$ 

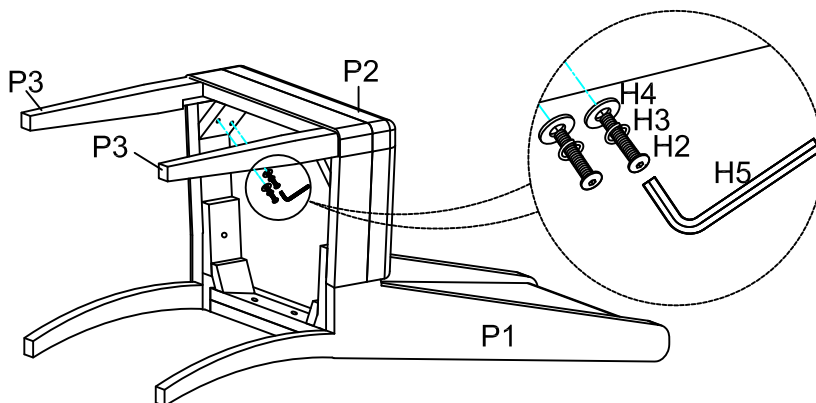

Step 4. Securely tighten all bolts with Allen wrench (H5), but do not over tighten the bolts. Turn the assembled chair to upright position. Make sure the chair is level. Assembly is complete. **Failure to follow these unstructions may cause the bolts to misalign during assembly.**

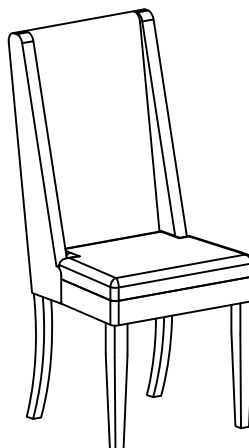

ADDITIONAL NOTE ABOUT SAFETY: BOLTS MAY LOOSEN DURING NORMAL EVERYDAY USE. THEY SHOULD BE PERIODICALLY INSPECTED AND RE-TIGHTENED TO PREVENT DAMAGE OR INJURY. ALWAYS CHECK TO ENSURE THAT ALL HARDWARE IS KEPT TIGHTENED.

Thank you for your purchase