



ASSEMBLY INSTRUCTIONS

Description: Winfield Dining Chair



Important safety instructions:

- Please read carefully all instructions before assembling.
- For your safety and ease, assembly by two or more adults is recommended.
- Keep instructions for future use.

Pre-assembly:



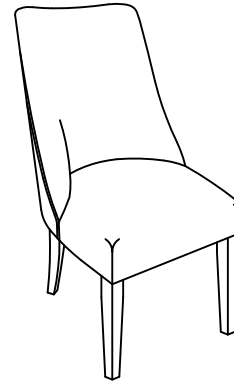

- Do not discard any content until assembly completed to avoid accidentally discarding small parts or hardware.
- Take out all parts and hardwares from box.

Parts List

Item	Description	QTY
P1	Chair Body 	1
P2	Front Leg 	2
P3	Back Leg 	2



Hardware List





Item	Description	QTY
H1	Bolt $\phi 5/16$ "*1-5/8"L 	8
H2	Lock Washer $\phi 5/16$ " 	8
H3	Flat Washer $\phi 5/16$ " 	8
H4	Allen Wrench $\phi 5/16$ " 	1

DISCLAIMER:

WHEN PROPERLY ASSEMBLED, THIS ITEM IS SAFE FOR INTENDED USE. SELLER IS NOT LIABLE FOR ANY DAMAGES RESULTING FROM ITEM BEING IMPROPERLY ASSEMBLED AFTER PURCHASE.

Assembly Procedures:

Step 1. Assemble the chair on a flat and soft surface either on a carpet or cloth to prevent the finish from scratching. To locate the legs and hardware, please turn the chair upside down, you will find the components beneath the fabric cover that is secured by a Velcro strap underneath the seat cushion. Lift the strap upwards, legs and hardware box could be located beneath the fabric cover. Open the box and take out the legs and hardware, then attach the front legs (P2) and back legs (P3) to the bottom of chair body (P1) as shown below image 1.

- (H1)x8 Bolt $\phi 5/16$ "*1-5/8"L 
- (H2)x8 Lock Washer $\phi 5/16$ " 
- (H3)x8 Flat Washer $\phi 5/16$ " 
- (H4)x1 Allen Wrench $\phi 5/16$ " 

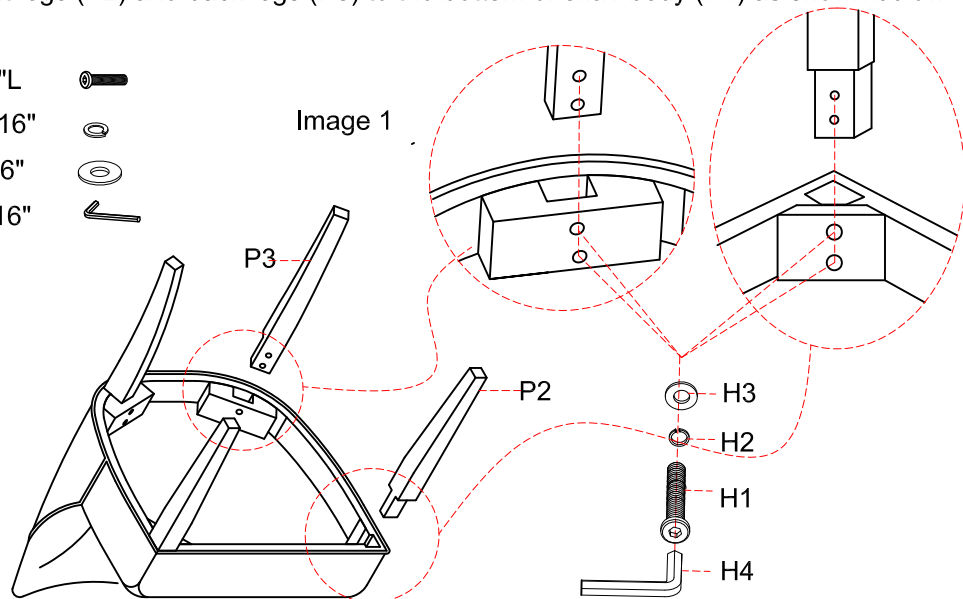

Step 2. Securely tighten all bolts, turn the assembled chair to an upright position. Make sure the chair is leveled and aligned properly, assembly is complete. **Failure to follow these instructions may cause the bolts to misalign during assembly.**

ADDITIONAL NOTE ABOUT SAFETY: BOLTS MAY LOOSEN DURING NORMAL EVERYDAY USE. THEY SHOULD BE PERIODICALLY INSPECTED AND RE-TIGHTENED TO PREVENT DAMAGE OR INJURY. ALWAYS CHECK TO ENSURE THAT ALL HARDWARE IS KEPT TIGHTENED.

Thank you for your purchase