

ASSEMBLY INSTRUCTIONS

Description: Boomerange Lounge





Important safety instructions:

- Please read carefully all instructions before assembly.
- For your safety and ease, assembly by two or more adults is recommended.
- Keep instructions for future use.







Pre-assembly:

- Do not discard any content until assembly is complete to avoid accidentally discarding small parts or hardware.
- Take out all parts and hardware from box.

Parts List

Item	Description	QTY
P1	Lounge Top 	1
P2	Left Leg  (P2)	1
P3	Right Leg  (P3)	1
P4	Strecher 	1
P5	Pillow 	1

Hardware List

Item	Description	QTY
H1	Long Bolts Ø1/4*3-1/2" 	4
H2	Short Bolts Ø1/4*2" 	2
H3	Lock Washers Ø1/4" 	6
H4	Big Flat Washers Ø1/4" *19mm 	4
H5	Small Flat Washers Ø1/4" *12mm 	2
H6	Allen Wrench 1/4" 	1
H7	Wooden Plugs 	2

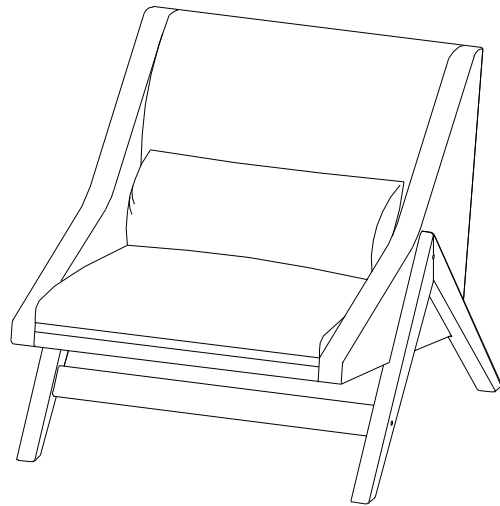





DISCLAIMER:

WHEN PROPERLY ASSEMBLED, THIS ITEM IS SAFE FOR INTENDED USE. SELLER IS NOT LIABLE FOR ANY DAMAGES RESULTING FROM ITEM BEING IMPROPERLY ASSEMBLED AFTER PURCHASE.

Assembly Procedures:



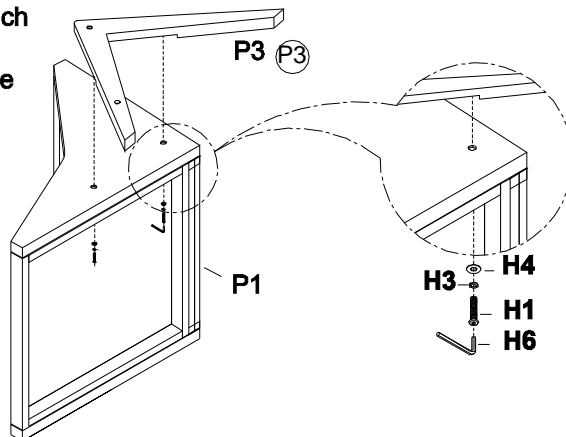

Step 1. Assemble the lounge on a flat, soft surface such as a carpet or cloth to prevent scratching the finish. Attach right leg (P3) to lounge top (P1) according to the label "P3" on the right leg as shown below. Securely tighten all bolts with Allen wrench (H6) .

- (H1)x2 Long Bolts 
- (H3)x2 Lock Washers 
- (H4)x2 Big Flat Washers 
- (H6)x1 Allen Wrench 



Step 2.

- 1) Insert stretcher (P4) to the right leg (P3) according to the label "P3" on the right leg.
- 2) Loosely Attach left leg (P2) to lounge top (P1) and stretcher (P4) according to the label "P2" on the left leg (P2) as shown in below. Securely tighten all bolts with Allen wrench (H6).

- (H1)x2 Long Bolts 
- (H2)x2 Short Bolts 
- (H3)x4 Lock Washers 
- (H4)x2 Big Flat Washers 
- (H5)x2 Small Flat Washers 

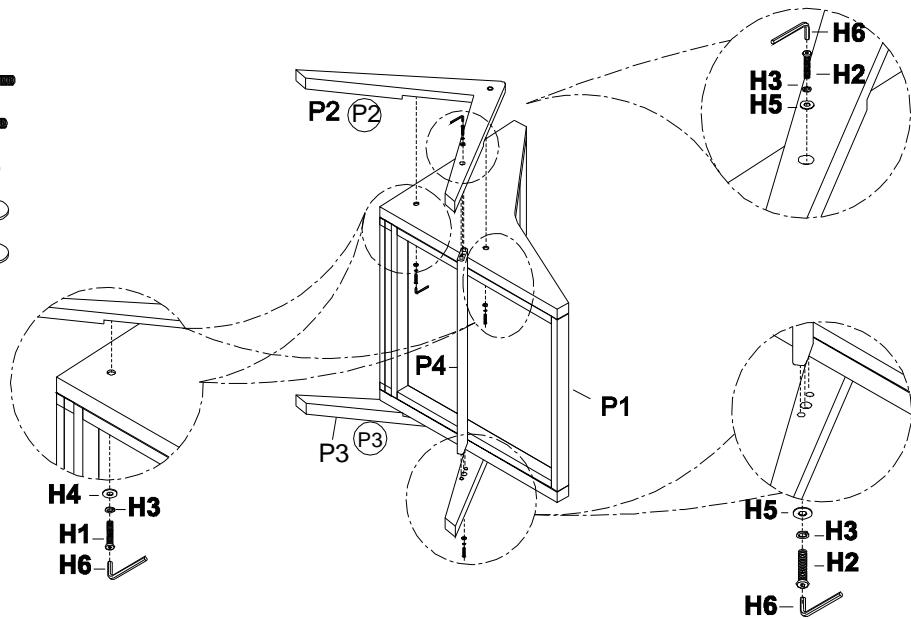

Step 3.

- 1) Turn the assembled lounge to an upright position. Securely tighten all the bolts and with Allen wrench (H6), but do not over tighten the bolts.
- 2) Attach wooden plugs (H7) to each bolt hole, tighten with rubber hammer to knock the wooden plug till its tighten. Note: use a soft cloth between the wooden plug and hammer to prevent damage to wooden plug finish.
- 3) Assembly is completed. Put the pillow (P5) on the assembled lounge.

- (H7)x2 Wooden Plugs 

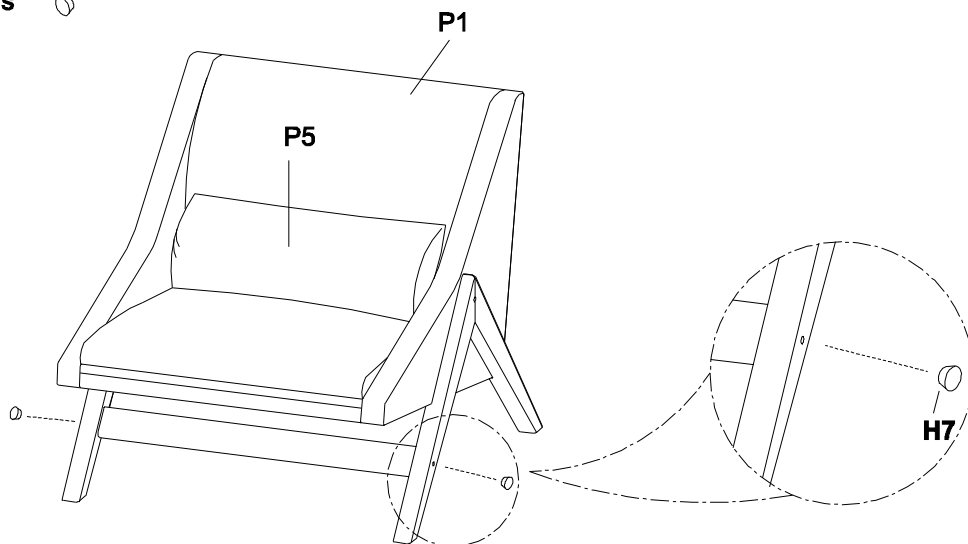

ADDITIONAL NOTE ABOUT SAFETY: BOLTS MAY LOOSEN DURING NORMAL EVERYDAY USE. THEY SHOULD BE PERIODICALLY INSPECTED AND RE-TIGHTENED TO PREVENT DAMAGE OR INJURY. ALWAYS CHECK TO ENSURE THAT ALL HARDWARE IS KEPT TIGHTENED.

Thank you for your purchase