



ASSEMBLY INSTRUCTIONS

Description: Harstrom Storage Bench



Important safety instructions:

- Please read carefully all instructions before assembly.
- For your safety and ease, assembly by two or more adults is recommended.
- Keep instructions for future use.

Pre-assembly:



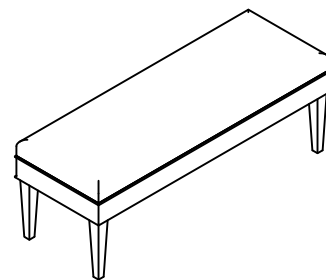

- Do not discard any content until assembly is complete to avoid accidentally discarding small parts or hardware.
- Take out all parts and hardware from box.

Parts List

Item	Description	QTY
P1	Seat Cushion 	1
P2	Legs 	4







Hardware List

Item	Description	QTY
H1	Bolts $\text{Ø}5/16'' \times 1-1/2''$ 	8
H2	Lock Washers $\text{Ø}5/16''$ 	8
H3	Flat Washers $\text{Ø}5/16'' \times 19\text{mm}$ 	8
H4	Allen Wrench $5/16''$ 	1
H5	Sticker 	4

Assembly Procedures:

Step 1: Assemble the chair on a flat, soft surface such as a carpet or cloth to prevent scratching the finish. Attach the legs (P2) to the seat cushion (P1) as shown below.

- (H1)x8 Bolts $\text{Ø}5/16'' \times 1-1/2''$ 
- (H2)x8 Lock Washers $5/16''$ 
- (H3)x8 Flat Washers $5/16''$ 
- (H4)x1 Allen Wrench $5/16''$ 

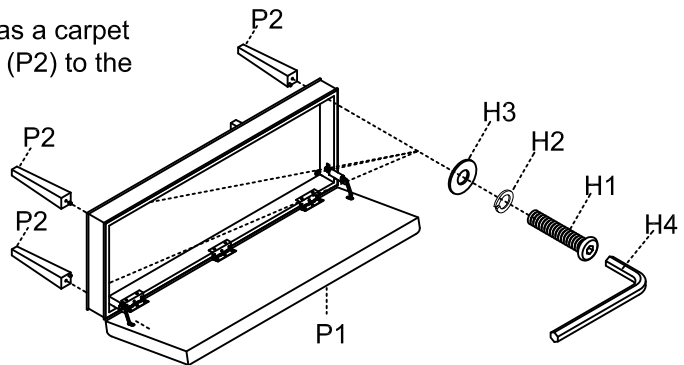

Step 2. Securely tighten all bolts, turn the assembled bench to an upright position, put the stickers (H5) to cover the holes as shown below. Assembly is complete. **Failure to follow these instructions may cause the bolts to misalign during assembly.**

- (H5)x4 Sticker 

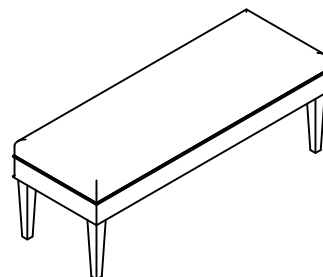
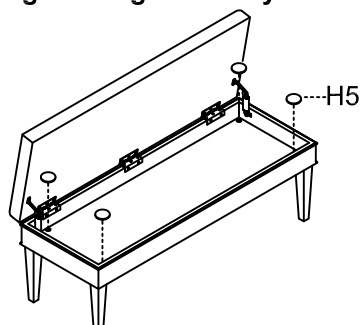

ADDITIONAL NOTE ABOUT SAFETY: BOLTS MAY LOOSEN DURING NORMAL EVERYDAY USE. THEY SHOULD BE PERIODICALLY INSPECTED AND RE-TIGHTENED TO PREVENT DAMAGE OR INJURY. ALWAYS CHECK TO ENSURE THAT ALL HARDWARE IS KEPT TIGHTENED.

Thank you for your purchase