



ASSEMBLY INSTRUCTIONS

Description: Remo Accent Chair



Important safety instructions:

- Please read carefully all instructions before assembly.
- For your safety and ease, assembly by two or more adults is recommended.
- Keep instructions for future use.

Pre-assembly:



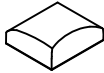

- Do not discard any content until assembly is complete to avoid accidentally discarding small parts or hardware.
- Take out all parts and hardware from box.

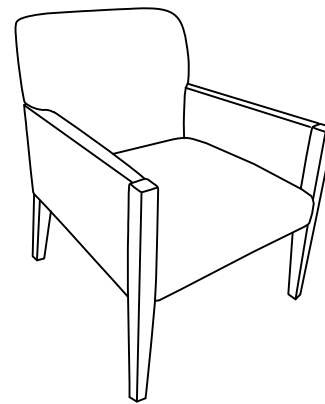
Parts List

Item	Description	QTY
P1	Back Cushion 	1
P2	Seat Cushion 	1
P3	Left Arm with Legs  (P3)	1
P4	Right Arm with Legs  (P4)	1



Hardware List





Item	Description	QTY
H1	Bolts Ø5/16"*2-1/4" 	10
H2	Lock Washers Ø5/16" 	10
H3	Flat Washers Ø5/16" 	10
H4	Allen Wrench 5/16" 	1

DISCLAIMER:

WHEN PROPERLY ASSEMBLED, THIS ITEM IS SAFE FOR INTENDED USE. SELLER IS NOT LIABLE FOR ANY DAMAGES RESULTING FROM ITEM BEING IMPROPERLY ASSEMBLED AFTER PURCHASE.



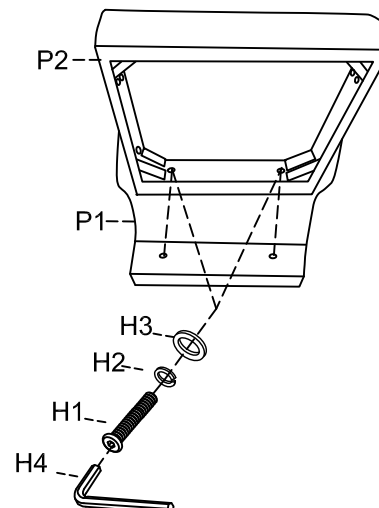

Assembly Procedures:

Step 1: Assemble the chair on a flat and soft surface either on a carpet or cloth to prevent the finish from scratching. Loosely attach the seat cushion (P2) to the back cushion (P1) as shown.

- | | | |
|--------|---------------------|---|
| (H1)x2 | Bolts Ø5/16"*2-1/4" |  |
| (H2)x2 | Lock Washers Ø5/16" |  |
| (H3)x2 | Flat Washers Ø5/16" |  |
| (H4)x1 | Allen Wrench 5/16" |  |





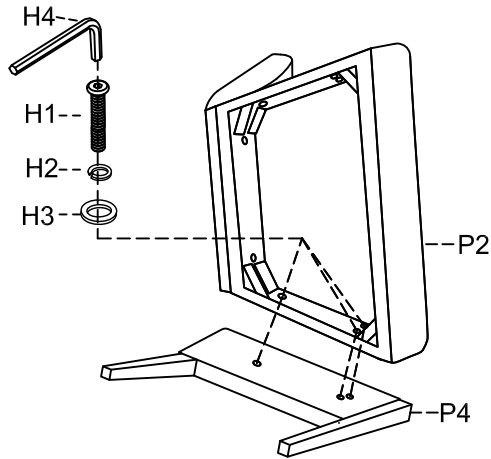

Step 2. Loosely attach the assembled seat cushion (P2) to the right arm with legs (P4) as shown.

- (H1)x3 Bolts $\text{\O}5/16'' \times 2-1/4''$ 
- (H2)x3 Lock Washers $\text{\O}5/16''$ 
- (H3)x3 Flat Washers $\text{\O}5/16''$ 
- (H4)x1 Allen Wrench $5/16''$ 





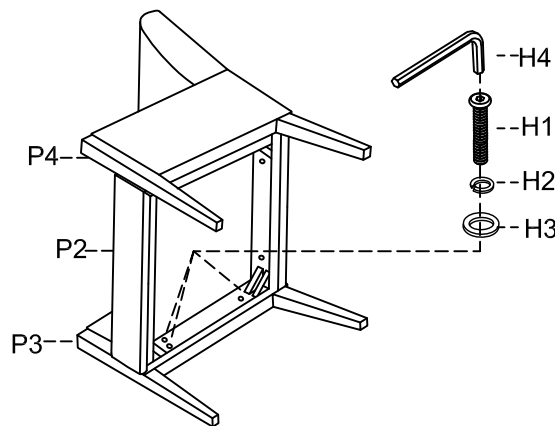

Step 3. Loosely attach the assembled seat cushion (P2) to the left arm with legs (P3) as shown.

- (H1)x3 Bolts $\text{\O}5/16'' \times 2-1/4''$ 
- (H2)x3 Lock Washers $\text{\O}5/16''$ 
- (H3)x3 Flat Washers $\text{\O}5/16''$ 
- (H4)x1 Allen Wrench $5/16''$ 



Step 4. Turn the assembled chair to an upright position. Open the back fabric, then attach the back cushion (P1) to the left arm with legs (P3) and right arm with legs (P4) as shown. Make sure the chair is level and securely tighten all bolts with Allen wrench (H5).

Leveler adjustment: Levelers are pre-installed on the front legs and adjust as needed to make sure the chair is level. Assembly is complete. **Failure to follow these instructions may cause the bolts to misalign during assembly.**

- (H1)x2 Bolts $\text{\O}5/16'' \times 2-1/4''$ 
- (H2)x2 Lock Washers $\text{\O}5/16''$ 
- (H3)x2 Flat Washers $\text{\O}5/16''$ 
- (H4)x1 Allen Wrench $5/16''$ 

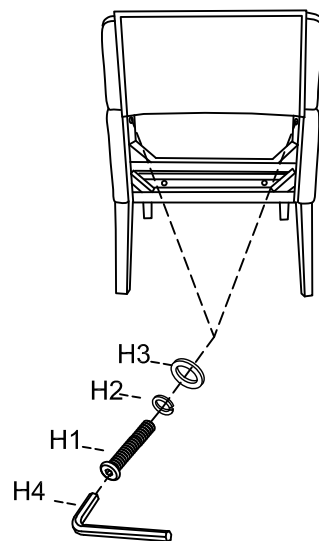
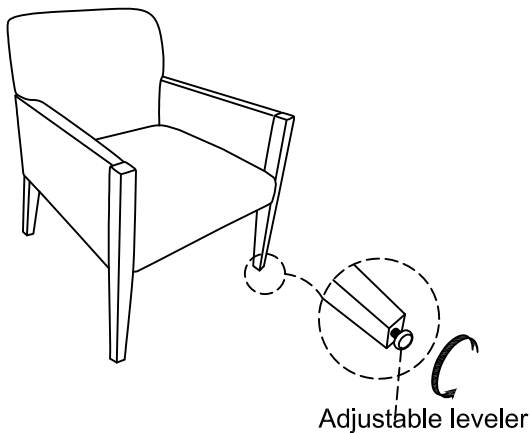

ADDITIONAL NOTE ABOUT SAFETY: BOLTS MAY LOOSEN DURING NORMAL EVERYDAY USE. THEY SHOULD BE PERIODICALLY INSPECTED AND RE-TIGHTENED TO PREVENT DAMAGE OR INJURY. ALWAYS CHECK TO ENSURE THAT ALL HARDWARE IS KEPT TIGHTENED.

Thank you for your purchase