

# ASSEMBLY INSTRUCTIONS

Description: Nate Counter & Bar Stool





**Important safety instructions:**

- Please read carefully all instructions before assembly.
- For your safety and ease, assembly by two or more adults is recommended.
- Keep instructions for future use.

**Pre-assembly:**





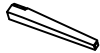

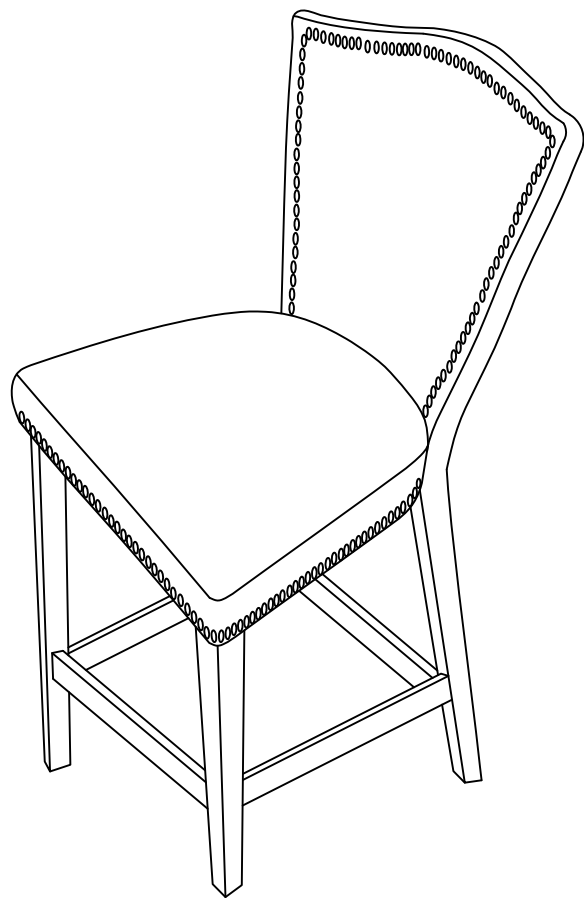
- Do not discard any content until assembly is complete to avoid accidentally discarding small parts or hardware.
- Take out all parts and hardware from box.

**Parts List**

Item	Description		QTY
P1	Chair Back		1
P2	Seat Cushion		1
P3	Left Stretcher	 Ⓛ	1
P4	Right Stretcher	 Ⓡ	1
P5	Front Stretcher		1
P6	Front Legs		2



**Hardware List**

Item	Description		QTY
H1	Long Bolts Ø5/16"*2-1/4"		5
H2	Short Bolts Ø5/16"*2"		4
H3	Lock Washers 5/16"		9
H4	Flat Washers 5/16"		9
H5	Allen Wrench 5/16"		1
H6	Screw #8*1-3/4"		6

**DISCLAIMER:**

WHEN PROPERLY ASSEMBLED, THIS ITEM IS SAFE FOR INTENDED USE. SELLER IS NOT LIABLE FOR ANY DAMAGES RESULTING FROM ITEM BEING IMPROPERLY ASSEMBLED AFTER PURCHASE.



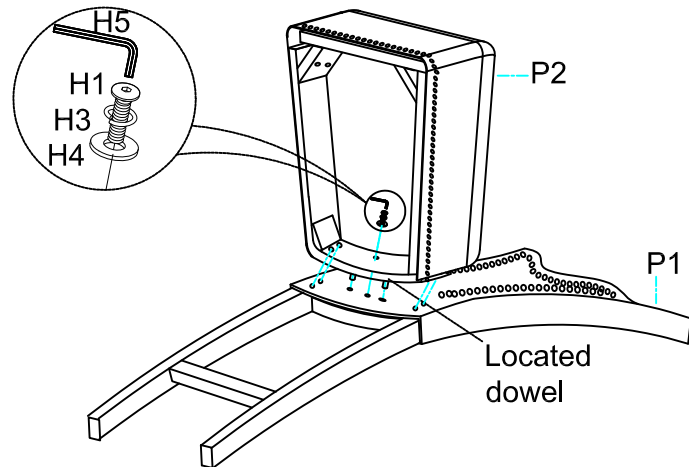

## Assembly Procedures:

Step 1. Assemble the stool on a flat, soft surface such as a carpet or cloth to prevent scratching the finish. Insert dowel into the chair back (P1), then attach the seat cushion (P2) to chair back (P1) as shown below. Loosely tighten the bolts with Allen wrench (H5).

- (H1)x1 Long Bolts  $\text{Ø}5/16'' \times 2-1/4''$  
- (H3)x1 Lock Washers 5/16" 
- (H4)x1 Flat Washers 5/16" 
- (H5)x1 Allen Wrench 5/16" 



Step 2. Attach the seat cushion (P2) to the leg of chair back (P1) as shown below. Loosely tighten the bolts with Allen wrench (H5).

- (H1)x4 Long Bolts  $\text{Ø}5/16'' \times 2-1/4''$  
- (H3)x4 Lock Washers 5/16" 
- (H4)x4 Flat Washers 5/16" 
- (H5)x1 Allen Wrench 5/16" 

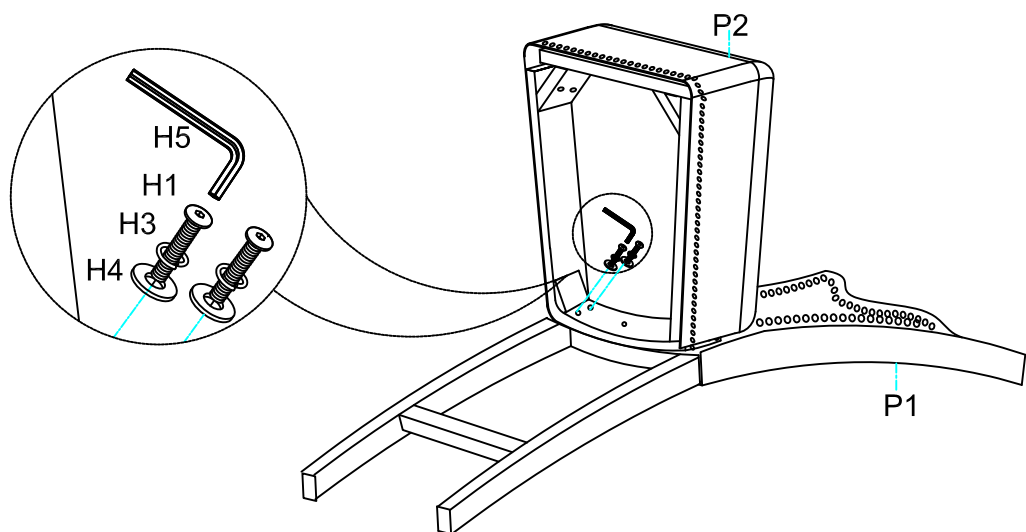

Step 3. Insert the right stretcher (P4) to the leg of chair back (P1) according to the label "R" at the hole in the legs of stool and the front end of right stretcher (P4). Loosely attach the front leg (P6) to the bottom of seat cushion (P2) and the stretcher (P4) as shown below. Do not tighten the screws at this time.

- (H2)x2 Short Bolts  $\varnothing 5/16 \times 2$ "
- (H3)x2 Lock Washers 5/16"
- (H4)x2 Flat Washers 5/16"
- (H5)x1 Allen Wrench 5/16"

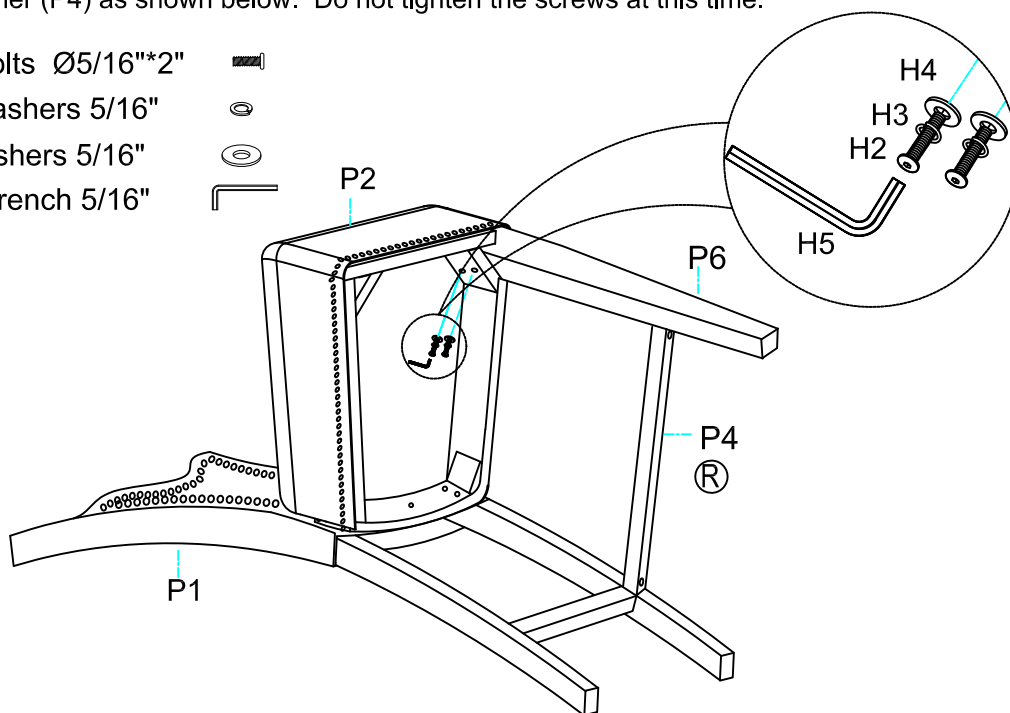

Step 4.

- 1) Insert the left stretcher (P3) to the leg of chair back (P1) according to the label "L" at the holes in the legs of chair back and the front end of left stretcher (P3). Loosely attach the front leg (P6) to the seat cushion (P2) as shown below. Do not tighten the screws at this time.
- 2) Insert the front stretcher (P5) between the front legs (P6).
- 3) Securely tighten all bolts, but do not over tighten the bolts.
- 4) Tighten all screws (H6) through the stretchers (P3, P4, P5) to the front legs (P6) and chair back legs with screw driver(not provided).
- 5) Assembly is complete.

- (H2)x2 Short Bolts  $\varnothing 5/16 \times 2$ "
- (H3)x2 Lock Washers 5/16"
- (H4)x2 Flat Washers 5/16"
- (H5)x1 Allen Wrench 5/16"
- (H6)x6 Screw #8\*1-3/4"

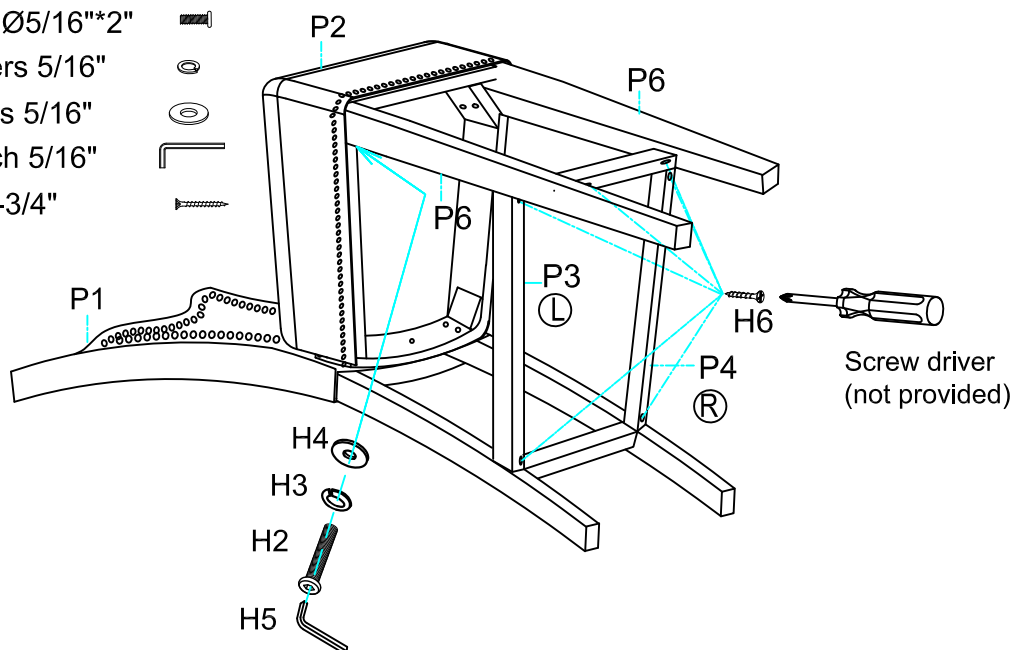

**ADDITIONAL NOTE ABOUT SAFETY: BOLTS MAY LOOSEN DURING NORMAL EVERYDAY USE. THEY SHOULD BE PERIODICALLY INSPECTED AND RE-TIGHTENED TO PREVENT DAMAGE OR INJURY. ALWAYS CHECK TO ENSURE THAT ALL HARDWARE IS KEPT TIGHTENED.**

Thank you for your purchase