

# MADISONPARK® ASSEMBLY INSTRUCTIONS

## Elmwood Dining Chair







### Important safety instructions:

- Please read carefully all instructions before assembly.
- For your safety and ease, assembly by two or more adults is recommended.
- Keep instructions for future use.

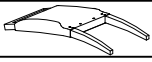







### Pre-assembly:

- Do not discard any content until assembly is complete to avoid accidentally discarding small parts or hardware.
- Take out all parts and hardware from box.

### Parts List

Item	Description	QTY
P1	Chair Back 	1
P2	Seat Cushion 	1
P3	Front Legs 	2
P4	Front Rail 	1
P5	Left Rail  (P5)	1
P6	Right Rail  (P6)	1

### Hardware List

Item	Description	QTY
H1	Short Bolts Ø5/16"*1-1/2"L 	2
H2	Medium Bolts Ø5/16"*2"L 	4
H3	Long Bolts Ø5/16"*3"L 	4
H4	Lock Washers 5/16" 	10
H5	Flat Washers 5/16" 	10
H6	Allen Wrench 5/16" 	1
H7	Screw #8*1-1/4 	6
H8	Screwdriver(not provide) 	1

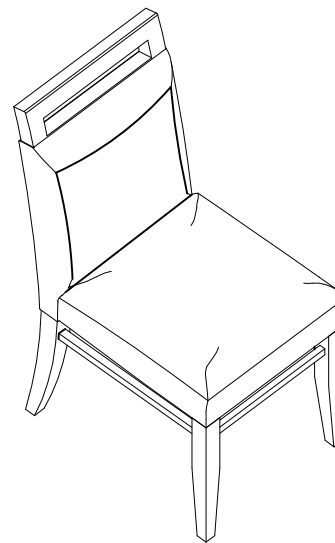

### DISCLAIMER:

WHEN PROPERLY ASSEMBLED, THIS ITEM IS SAFE FOR INTENDED USE. SELLER IS NOT LIABLE FOR ANY DAMAGES RESULTING FROM ITEM BEING IMPROPERLY ASSEMBLED AFTER PURCHASE.

### Assembly Procedures:

Step 1. Assemble the chair on a flat, soft surface such as a carpet or cloth to prevent scratching the finish.

Insert the front rail (P4) to the front legs (P3), then insert the legs (P3) to the bottom of seat cushion (P2) as shown below image 1.

(H2)x4 Medium Bolts Ø5/16"\*2"L 

(H4)x4 Lock Washers 5/16" 

(H5)x4 Flat washers 5/16" 

(H6)x1 Allen Wrench 5/16" 

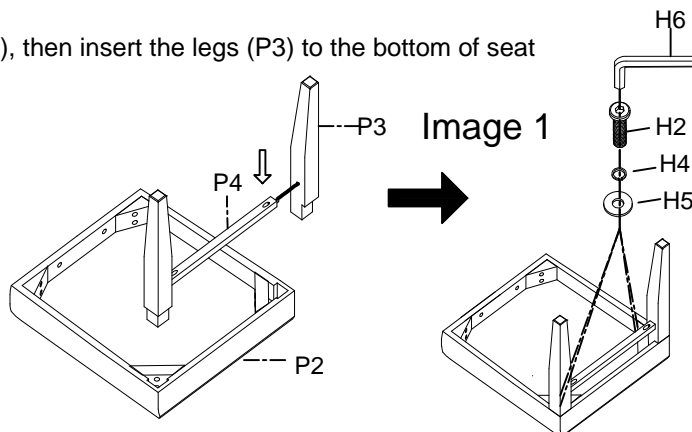

Step 2. 1) With one person to help, insert the left rail (P5) and right rail (P6) to the front legs (P3), then insert left rail (P5) and right rail (P6) to the legs of chair back (P1) as shown below image 2.  
 2) Assemble the seat cushion(P2) to the chair back (P1) as shown below image 3.

(H1)x2 Short Bolts Ø5/16"\*1-1/2"L



(H2)x4 Long Bolts Ø5/16"\*3"L



(H4)x6 Lock Washers 5/16"



(H5)x6 Flat washers 5/16"



(H6)x1 Allen Wrench 5/16"



(H7)x6 Screws #8\*1-1/4"

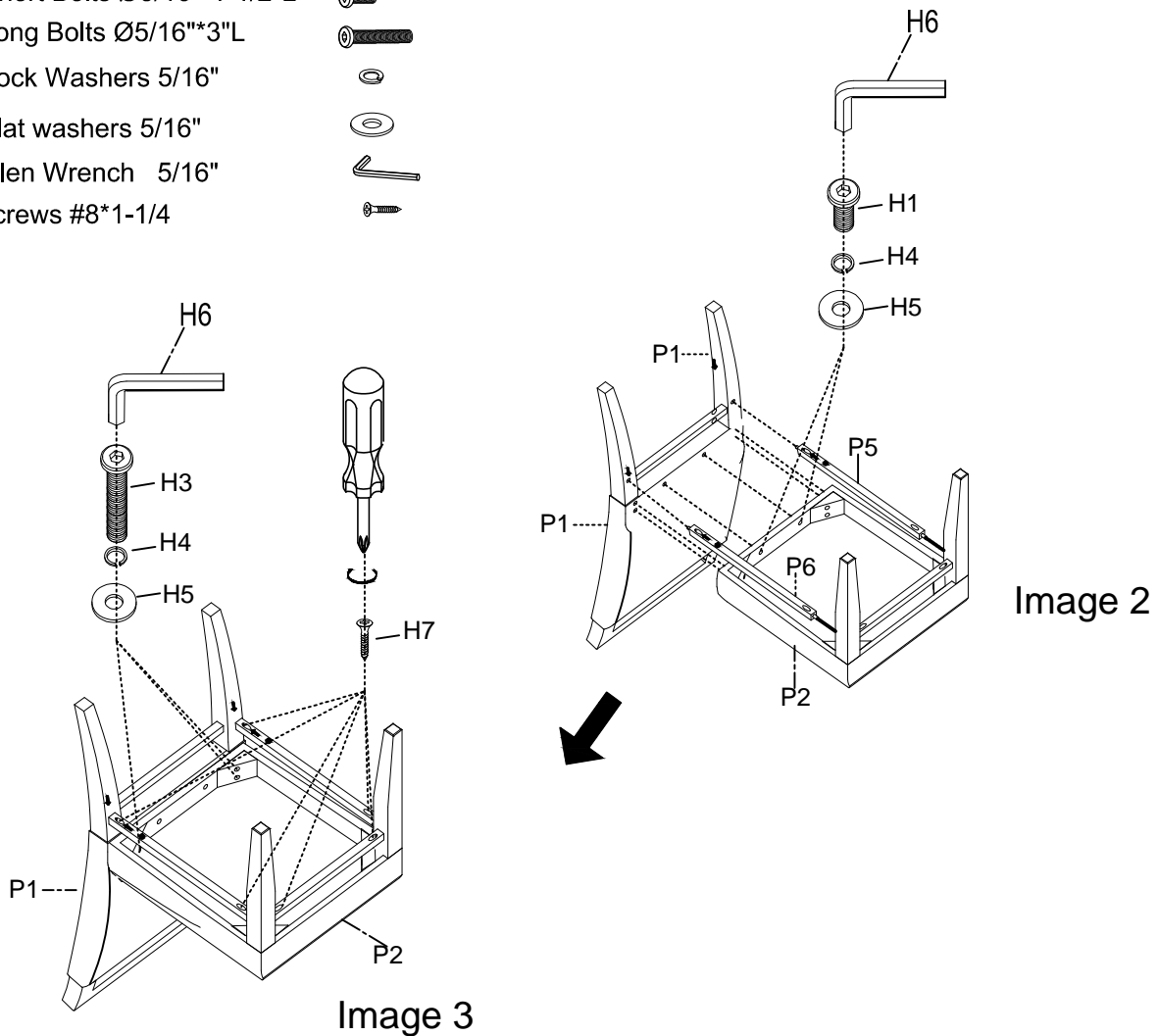

Step 3. Turn the assembled chair to an upright position. Make sure the chair is leveled and aligned properly, assembly is complete. **Failure to follow these instructions may cause the bolts to misalign during assembly.**

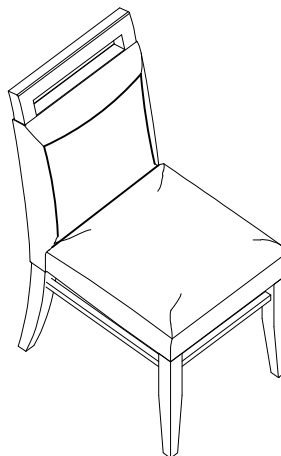

**ADDITIONAL NOTE ABOUT SAFETY: BOLTS MAY LOOSEN DURING NORMAL EVERYDAY USE. THEY SHOULD BE PERIODICALLY INSPECTED AND RE-TIGHTENED TO PREVENT DAMAGE OR INJURY. ALWAYS CHECK TO ENSURE THAT ALL HARDWARE IS KEPT TIGHTENED.**

Thank you for your purchase