

# ASSEMBLY INSTRUCTIONS

## Description: Brooklyn Arm Chair







**Important safety instructions:**

- Please read carefully all instructions before assembling.
- For your safety and ease, assembly by two or more adults is recommended.
- Keep instructions for future use.

**Pre-assembly:**







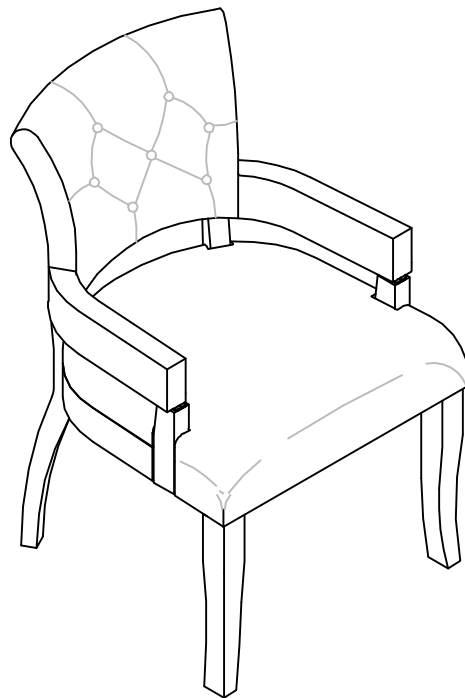



- Do not discard any content until assembly completed to avoid accidentally discarding small parts or hardware.
- Take out all parts and hardwares from box.

**Parts List**

Item	Description	QTY
P1	Chair Back Top 	1
P2	Front Legs 	2
P3	Back Right Leg  P3	1
P4	Back Left Leg  P4	1
P5	Seat Cushion 	1
P6	Right Arm Post  P6	1
P7	Left Arm Post  P7	1



**Hardware List**

Item	Description	QTY
H1	Big Long Bolts Ø5/16"x2-1/2" 	4
H2	Big Medium Bolts Ø5/16"x2" 	4
H3	Big Short Bolts Ø5/16"x1-1/2" 	4
H4	Small Bolts Ø1/4"x1" 	6
H5	Big Lock Washers 5/16" 	12
H6	Big Flat Washers 5/16" (22mm) 	12
H7	Small Lock Washers 1/4" 	6
H8	Small Flat Washers 1/4" (19mm) 	6
H9	Small Allen Wrench 1/4" 	1
H10	Big Allen Wrench 5/16" 	1

**DISCLAIMER:**



WHEN PROPERLY ASSEMBLED, THIS ITEM IS SAFE FOR INTENDED USE. SELLER IS NOT LIABLE FOR ANY DAMAGES RESULTING FROM ITEM BEING IMPROPERLY ASSEMBLED AFTER PURCHASE.

**Assembly Procedures:**

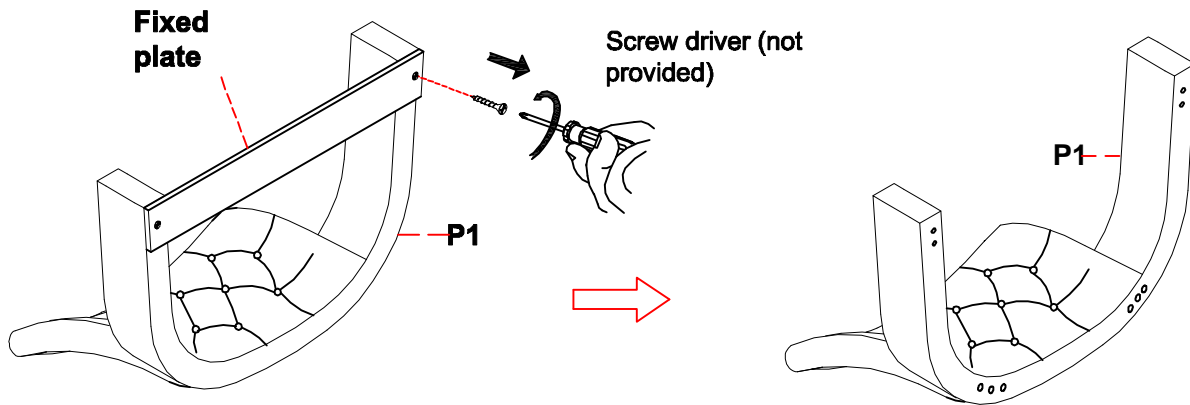
**Step 1.** Assemble the chair on a flat, soft surface such as a carpet or cloth to prevent scratching the finish. Remove the fixed plate from the bottom of chair back top (P1) by unscrewing out of the screws with screw driver(not provided).



**Step 2.** Attach the back legs (P3&P4) to chair back top (P1) according to the labels "P3","P4" on the legs as shown below. Securely tighten all bolts with Allen wrench (H9).

- (H4)x4 Small Bolts  $\text{\O}1/4\text{"x}1\text{"}$  
- (H7)x4 Small Lock Washers  $1/4\text{"}$  
- (H8)x4 Small Flat Washers  $1/4\text{"}$  
- (H9)x1 Allen Wrench  $1/4\text{"}$  

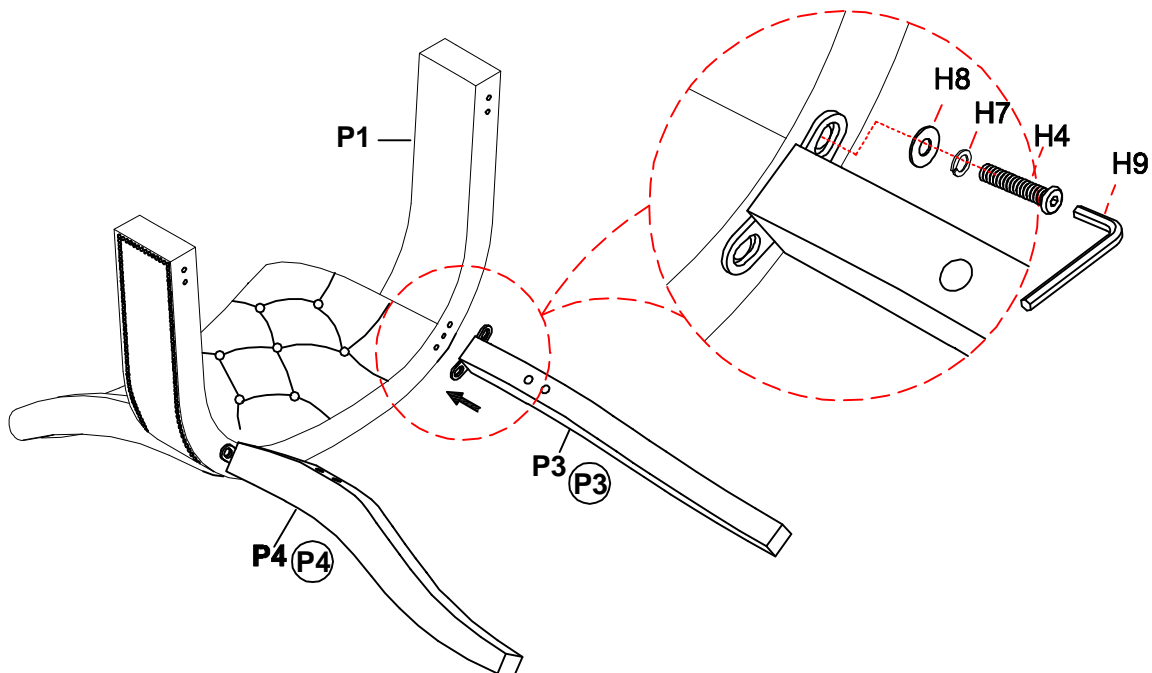







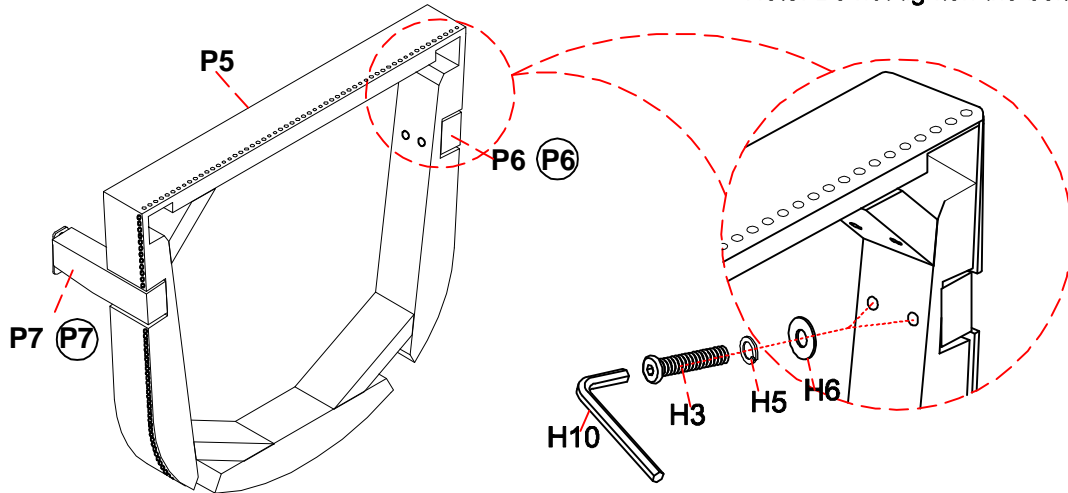

Step 3. Loosely attach the right arm post (P6) and the left arm post (P7) to seat cushion (P5) according to the labels "P6", "P7" on the arm posts as shown below. Loosely tighten with Allen wrench (H10).

- (H3)x4 Big Short Bolts  $\text{\O}5/16\text{"x}1\text{-}1/2\text{"}$  
- (H5)x4 Big Lock Washers  $5/16\text{"}$  
- (H6)x4 Big Flat Washers  $5/16\text{"}$  
- (H10)x1 Big Allen Wrench  $5/16\text{"}$  

Note: Do not tighten the bolts.



Step 4. Attach the assembled arm posts (P6, P7) and seat cushion (P5) to the bottom of chair back top (P1) and back legs (P3&P4) as shown below. Securely tighten the bolts with Allen wrench (H9 & H10).

- |   |   |
|---|---|
| (H2)x4 Big Medium Bolts $\text{\O}5/16\text{"x}2\text{"}$  | (H4)x2 Small Bolts $\text{\O}1/4\text{"x}1\text{"}$  |
| (H5)x4 Big Lock Washers $5/16\text{"}$                     | (H7)x2 Small Lock Washers $1/4\text{"}$              |
| (H6)x4 Big Flat Washers $5/16\text{"}$                     | (H8)x2 Small Flat Washers $1/4\text{"}$              |
| (H10)x1 Big Allen Wrench $5/16\text{"}$                    | (H9)x1 Allen Wrench $1/4\text{"}$                    |

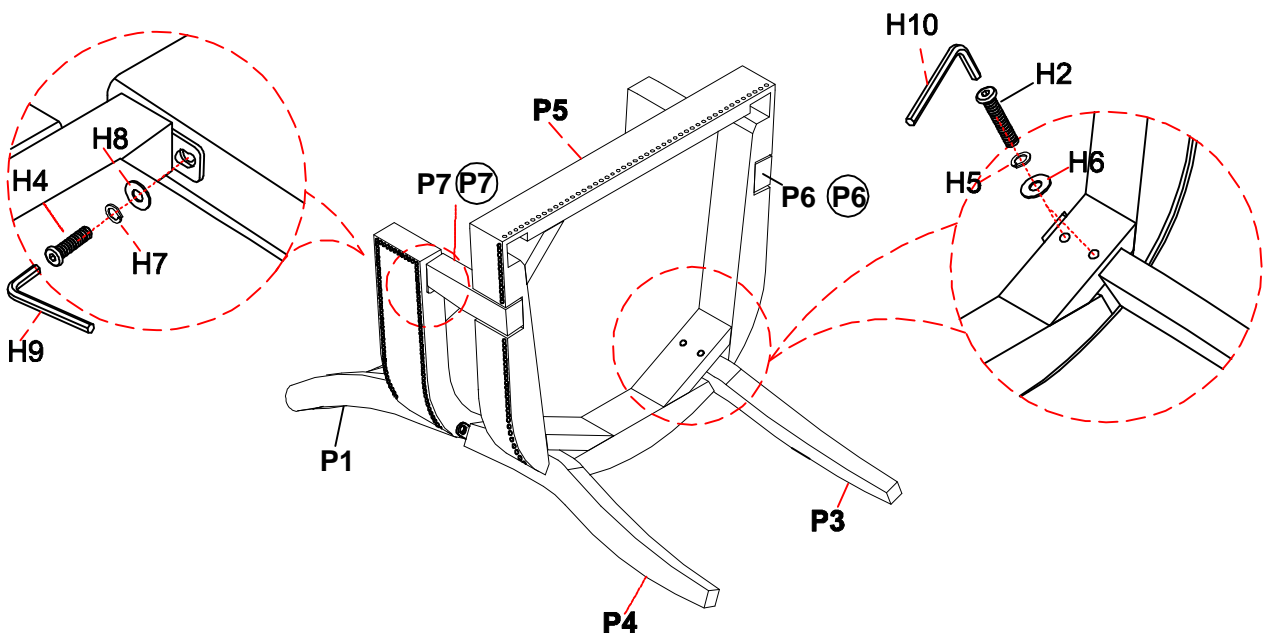

Step 5. Attach the front legs (P2) to the seat cushion (P5) as shown below. Securely tighten all bolts with Allen wrench (H10).

- (H1)x4 Big Long Bolts  $\text{Ø}5/16\text{''} \times 2\text{-}1/2\text{''}$
- (H5)x4 Big Lock Washers 5/16"
- (H6)x4 Big Flat Washers 5/16"
- (H10)x1 Big Allen Wrench 5/16"

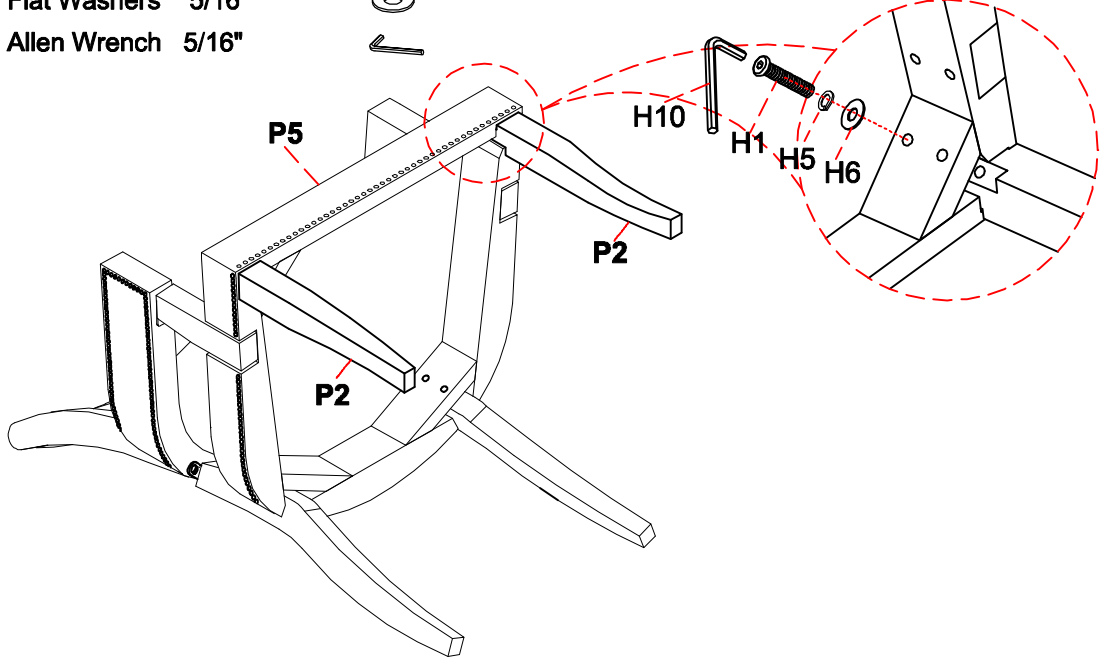

**Step 6.**

- 1) Turn the assembled chair to an upright position. Make sure the chair is level and securely tighten all bolts by Allen wrench (H9, H10).
- 2) Assembly is complete. **Failure to follow these instructions may cause the bolts to misalign during assembly.**

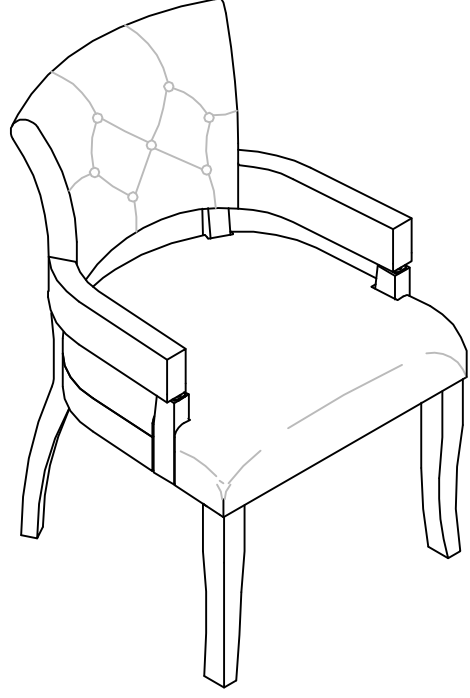

ADDITIONAL NOTE ABOUT SAFETY: BOLTS MAY LOOSEN DURING NORMAL EVERYDAY USE. THEY SHOULD BE PERIODICALLY INSPECTED AND RE-TIGHTENED TO PREVENT DAMAGE OR INJURY. ALWAYS CHECK TO ENSURE THAT ALL HARDWARE IS KEPT TIGHTENED.

**Thank you for your purchase**