







Important safety instructions:

- Please read carefully all instructions before assembly.
- For your safety and ease, assembly by two or more adults is recommended.
- Keep instructions for future use.

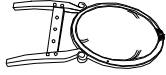
Pre-assembly:







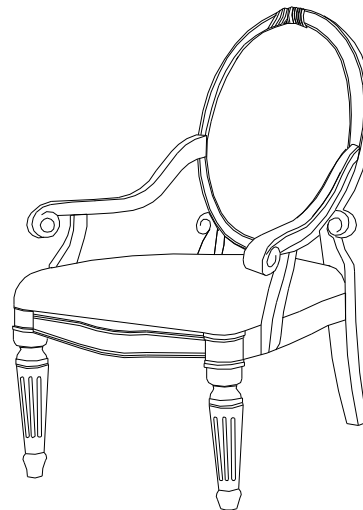



- Do not discard any content until assembly is complete to avoid accidentally discarding small parts or hardware.
- Take out all parts and hardware from box.

Parts List

Item	Description	QTY
P1	Chair Back 	1
P2	Front legs 	2
P3	Left Arm 	1
P4	Right Arm 	1
P5	Seat Frame 	1
P6	Seat Cushion 	1



Hardware List

Item	Description	QTY
H1	Big Long Bolts Ø5/16"*3"L 	4
H2	Big Medium Bolts Ø5/16"*2-1/2" 	4
H3	Big Short Bolts Ø5/16"*1-1/2" 	1
H4	Big Lock Washers 5/16" 	9
H5	Big Flat Washers 5/16" *3/4" 	9
H6	Big Allen Wrench 5/16" 	1
H7	Small Bolts Ø1/4"*1-1/2"L 	6
H8	Small Lock Washers 1/4" 	6
H9	Small Flat Washers 1/4" *5/8" 	6
H10	Small Allen Wrench 1/4" 	1
H11	Screws 	5
H12	Wooden Plugs 	2

DISCLAIMER:

WHEN PROPERLY ASSEMBLED, THIS ITEM IS SAFE FOR INTENDED USE. SELLER IS NOT LIABLE FOR ANY DAMAGES RESULTING FROM ITEM BEING IMPROPERLY ASSEMBLED AFTER PURCHASE.



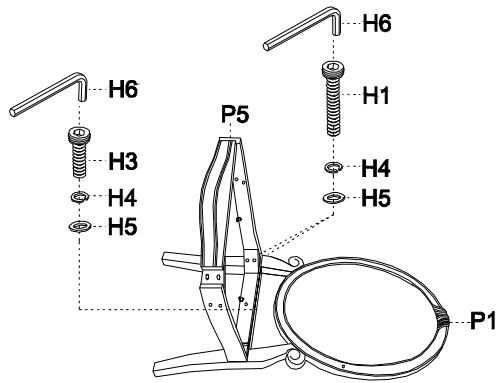

Assembly Procedures:

Step 1: Assemble the chair on a flat, soft surface such as a carpet or cloth to prevent scratching the finish. Attach the seat frame (P5) to the legs of chair back (P1) as shown below.

- (H1)x4 Big Long Bolts $\text{Ø}5/16 \times 3 \text{L}$ 
- (H3)x1 Big Short Bolts $\text{Ø}5/16 \times 1-1/2$ 
- (H4)x5 Big Lock Washers 5/16" 
- (H5)x5 Big Flat Washers 5/16" $\times 3/4$ 
- (H6)x1 Big Allen Wrench 



Step 2: Attach the front legs (P2) to the seat frame (P5) as shown below.

- (H2)x4 Big Medium Bolts $\text{Ø}5/16 \times 2-1/2$ 
- (H4)x4 Big Lock Washers 5/16" 
- (H5)x4 Big Flat Washers 5/16" $\times 3/4$ 
- (H6)x1 Big Allen Wrench 

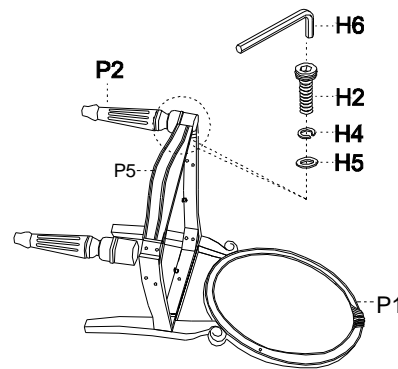

Step 3: Turn the assembled chair to an upright position. Attach the left arm (P3) and right arm (P4) to the seat frame (P5) and chair back (P1) as shown below.

- (H7)x4 Small Bolts $\text{Ø}1/4 \times 1-1/2 \text{L}$ 
- (H8)x4 Small Lock Washers 1/4" 
- (H9)x4 Small Flat Washers 1/4" $\times 5/8$ 
- (H10)x1 Small Allen Wrench 1/4" 

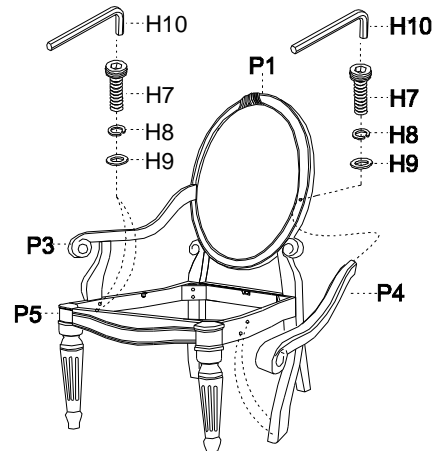

Step 4: Make sure the chair is level and securely tighten all bolts with Allen wrench (H6 & H10).

- a. Attach the seat cushion (P6) to the seat frame (P5) as shown below.
- b. Attach wooden plugs (H12) to each exposed bolt holes, tighten with rubber hammer to knock the wooden plug till its tighten. **Note:** use a soft cloth between the wooden plug and hammer to prevent damage to wooden plug finish.
- c. Assembly is complete. **Failure to follow these instructions may cause the bolts to misalign during assembly.**

- (H11)x5 Screws 
- (H12)x2 Wooden Plugs 

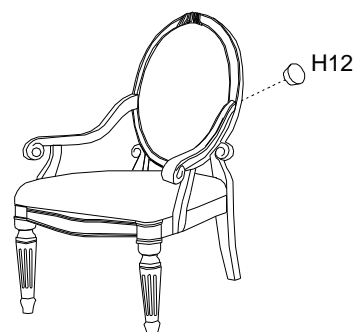
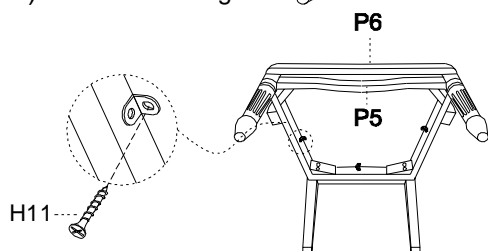

ADDITIONAL NOTE ABOUT SAFETY: BOLTS MAY LOOSEN DURING NORMAL EVERYDAY USE. THEY SHOULD BE PERIODICALLY INSPECTED AND RE-TIGHTENED TO PREVENT DAMAGE OR INJURY. ALWAYS CHECK TO ENSURE THAT ALL HARDWARE IS KEPT TIGHTENED.

Thank you for your purchase