







**Important safety instructions :**

- Please read carefully all instructions before assembly.
- For your safety and ease, assembly by two or more adults is recommended.
- Keep instructions for future use.

**Pre-assembly:**



- Do not discard any contents until assembly is complete to avoid accidentally discarding small parts or hardware.
- Remove all parts and hardware from box along with any plastic protective packaging.

Hardware List

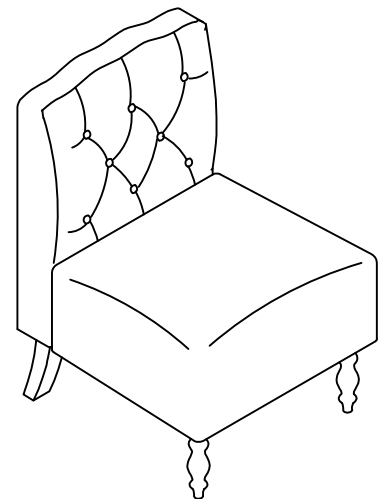
| Item | Description             |   | QTY |
|------|-------------------------|---|-----|
| A    | Short Bolts Ø5/16" x 2" |    | 5   |
| B    | Long Bolts Ø5/16" x 3"  |    | 4   |
| C    | Flat Washers 5/16"      |    | 9   |
| D    | Lock Washers 5/16"      |  | 9   |
| E    | Plastic washer          |  | 2   |
| F    | Allen Wrench 5/16"      |  | 1   |

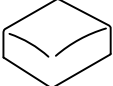

Parts List

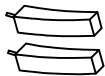
| Item | Description |   | QTY |
|------|-------------|---|-----|
| G    | Seat        |  | 1   |
| H    | Back Rest   |  | 1   |
| i    | Front Legs  |  | 2   |
| J    | Back Legs   |  | 2   |

**DISCLAIMER :**

**WHEN PROPERLY ASSEMBLED, THIS ITEM IS SAFE FOR INTENDED USE.  
SELLER IS NOT LIABLE FOR ANY DAMAGES RESULTING FROM ITEM BEING IMPROPERLY ASSEMBLED AFTER PURCHASE.**

## Assembly Procedures:

### Step 1

Attach front legs ( i ) to chair seat ( G ) using bolts ( B ), lock washers ( D ) and flat washers ( C ). Loosely tighten the bolts with Allen wrench ( F ) .

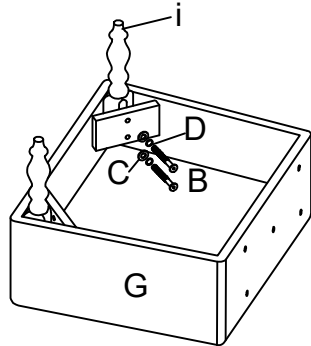

### Step 2:

Attach seat cushion ( G ) to back rest ( H ) using bolts ( A ), lock washers ( D ) and flat washers ( C ). Loosely tighten the bolts with Allen wrench ( F ) .

### Step 3:

Attach back leg ( J ) to back rest ( H ) . Place on plastic washer ( E ) to back panel hole. Rotate the back legs clockwise until fully tighten.

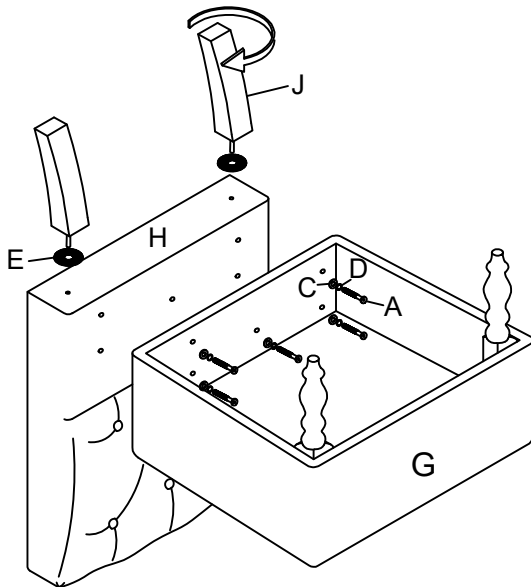

### Step 4:

Fully tighten all bolts . Assembly is complete.

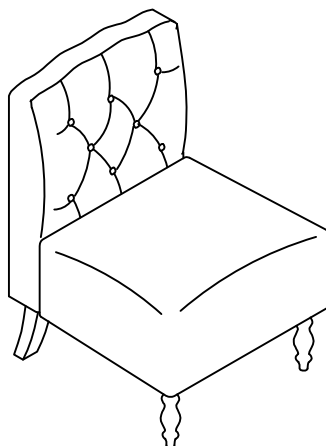

ADDITIONAL NOTE ABOUT SAFETY : BOLTS MAY LOOSEN DURING NORMAL EVERYDAY USE. THEY SHOULD BE PERIODICALLY INSPRCTED AND RE-TIGHTENED TO PREVENT DAMAGE OR INJURY.ALWAYS CHECK TO ENSURE THAT ALL HARDWARE IS KEPT TIGHTENED .

THANK YOU FOR YOUR PURCHASE