



**Important safety instructions:**

- Please read carefully all instructions before assembly.
- For your safety and ease, assembly by two or more adults is recommended.
- Keep instructions for future use.





**Pre-assembly:**

- Do not discard any content until assembly is complete to avoid accidentally discarding small parts or hardware.
- Take out all parts and hardware from box.

**Parts List**

Item	Description	QTY
P1	Top Panel 	1
P2	Metal Base 	1

**Hardware List**

Item	Description	QTY
H1	Bolts Ø1/4"x5/8" 	4
H2	Spring Washers Ø1/4" 	4
H3	Flat Washers Ø1/4" 	4
H4	Allen Wrench 4mm 	1

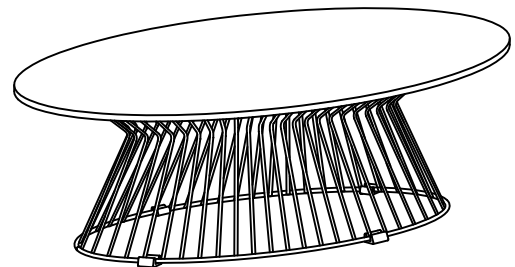

**DISCLAIMER:**

**WHEN PROPERLY ASSEMBLED, THIS ITEM IS SAFE FOR INTENDED USE. SELLER IS NOT LIABLE FOR ANY DAMAGES RESULTING FROM ITEM BEING IMPROPERLY ASSEMBLED AFTER PURCHASE.**

**Assembly Procedures:**

1. Turn the table top upside down on a flat, soft surface such as a carpet or cloth to prevent scratching the finish.
  - 1) Attach the metal base (P2) to the top panel (P1) as shown below. Securely tighten all bolts with Allen wrench (H4).
  - 2) Turn the assembled table to an upright position, assembly is complete.

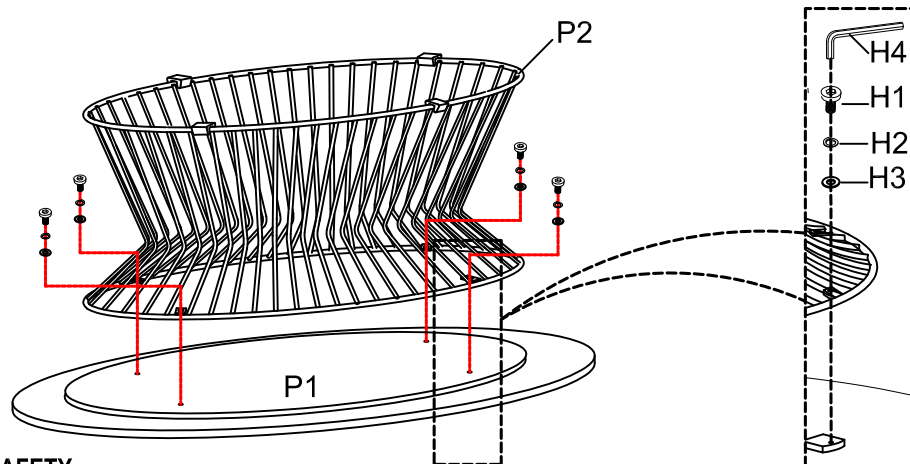

**ADDITIONAL NOTE ABOUT SAFETY:**

**BOLTS MAY LOOSEN DURING NORMAL EVERYDAY USE.**

**THEY SHOULD BE INSPECTED AT LEAST EVERY 3 MONTHS AND RE-TIGHTENED AS NEEDED TO PREVENT DAMAGE OR INJURY, AND ENSURE STABILITY.**

Thank you for your purchase