

ASSEMBLY INSTRUCTIONS

Description: Helena Counter Stool









Important safety instructions:

- Please read carefully all instructions before assembly.
- For your safety and ease, assembly by two or more adults is recommended.
- Keep instructions for future use.

Pre-assembly:



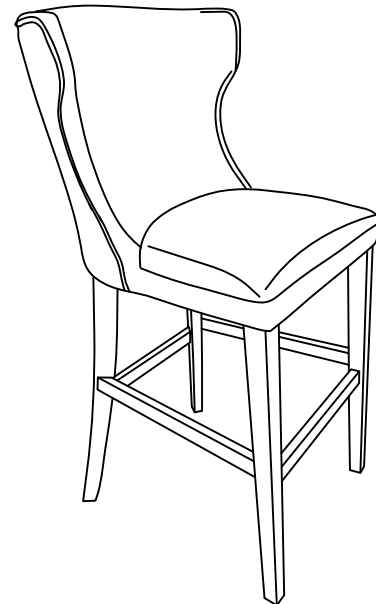

- Do not discard any content until assembly is complete to avoid accidentally discarding small parts or hardware.
- Take out all parts and hardware from box.

Parts List

Item	Description	QTY
P1	Chair Top 	1
P2	Left Front Leg 	1
P3	Right Front Leg 	1
P4	Left Back Leg 	1
P5	Right Back Leg 	1
P6	Front Stretcher 	1
P7	Left Side Stretcher 	1
P8	Right Side Stretcher 	1
P9	Back Stretcher 	1



Hardware List





Item	Description	QTY
H1	Bolts Ø5/16"x2"L 	8
H2	Lock Washers Ø5/16" 	8
H3	Flat Washers Ø5/16" 	8
H4	Allen Wrench Ø5/16" 	1
H5	Screws #8*1-1/2" 	8

DISCLAIMER:

WHEN PROPERLY ASSEMBLED, THIS ITEM IS SAFE FOR INTENDED USE. SELLER IS NOT LIABLE FOR ANY DAMAGES RESULTING FROM ITEM BEING IMPROPERLY ASSEMBLED AFTER PURCHASE.



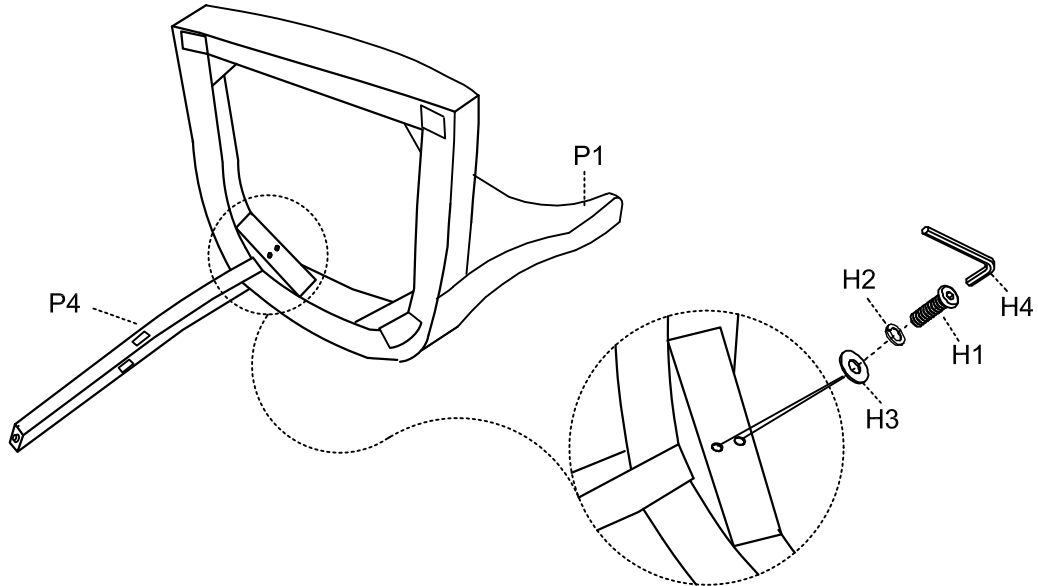

Assembly Procedures:

Step 1. Assemble the stool on a flat, soft surface such as a carpet or cloth to prevent scratching the finish. Loosely attach the left back leg (P4) to the bottom of chair top (P1) as shown below.

- (H1)x2 Bolts $\text{\O}5/16$ "x2"L 
- (H2)x2 Lock Washers $\text{\O}5/16$ " 
- (H3)x2 Flat Washers $\text{\O}5/16$ " 
- (H4)x1 Allen Wrench 



Step 2. Insert the back stretcher (P9) to left back leg (P4), then loosely attach the right back leg (P5) to the bottom of chair top (P1) and back stretcher (P9) as shown below.

- (H1)x2 Bolts $\text{\O}5/16$ "x2"L 
- (H2)x2 Lock Washers $\text{\O}5/16$ " 
- (H3)x2 Flat Washers $\text{\O}5/16$ " 
- (H4)x1 Allen Wrench 

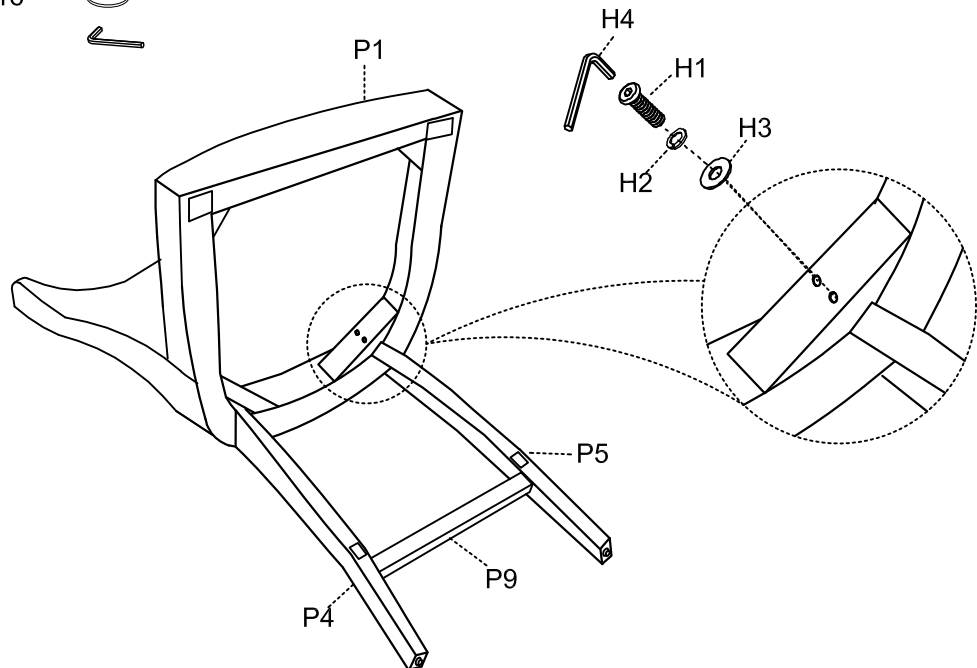

Step 3. Insert the right side stretcher (P8) to right back legs (P5), then loosely attach the right front leg (P3) to the bottom of chair top (P1) and right side stretcher (P8) as shown below.

- (H1)x2 Bolts $\varnothing 5/16$ "x2"L
- (H2)x2 Lock Washers $\varnothing 5/16$ "
- (H3)x2 Flat Washers $\varnothing 5/16$ "
- (H4)x1 Allen Wrench

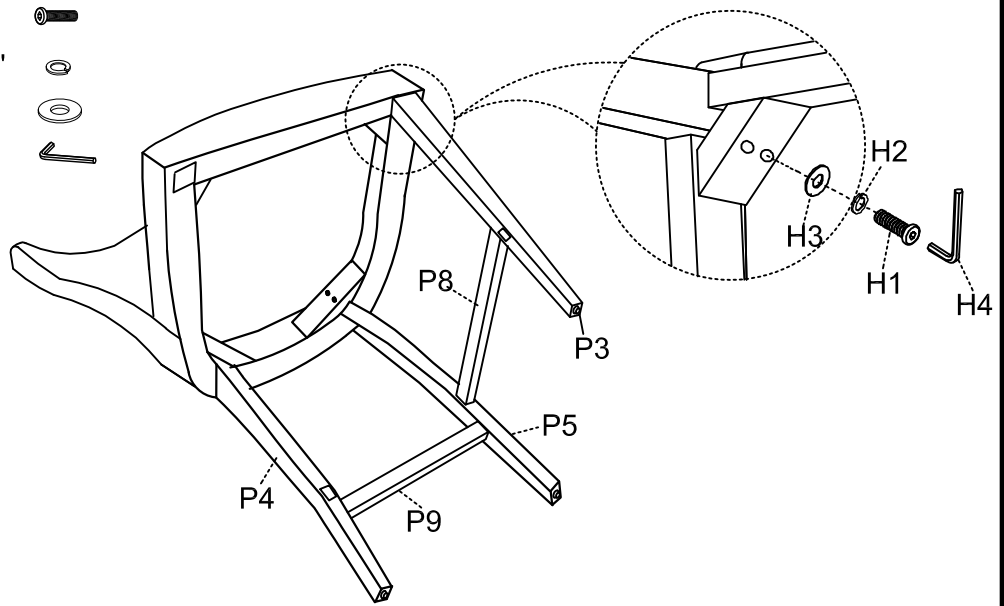

Step 4.

- 1) Insert front stretcher (P6) between front legs (P2,P3), and insert left stretcher (P7) between left front leg (P2) and the left back leg (P4), then **loosely** attach left front leg (P2) to the bottom of chair top (P1) as shown below.
- 2) Tighten screws (H5) through the stretchers (P6, P7, P8, P9) to each leg with screw driver (not provided).
- 3) Turn the assembled stool to an upright position. Make sure the stool is level and securely tighten all bolts by Allen wrench (H4).
- 4) Assembly is complete. **Failure to follow these instructions may cause the bolts to misalign during assembly.**

- (H1)x2 Bolts $\varnothing 5/16$ "x2"L
- (H2)x2 Lock Washers $\varnothing 5/16$ "
- (H3)x2 Flat Washers $\varnothing 5/16$ "
- (H4)x1 Allen Wrench
- (H5)x8 Screws #8*1-1/2"

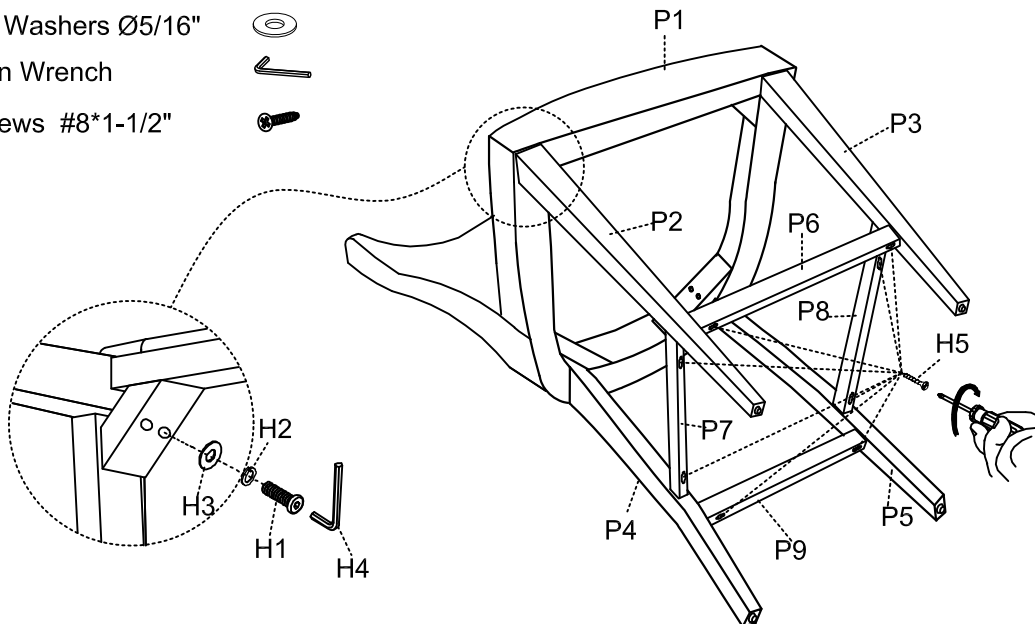

ADDITIONAL NOTE ABOUT SAFETY: BOLTS MAY LOOSEN DURING NORMAL EVERYDAY USE. THEY SHOULD BE PERIODICALLY INSPECTED AND RE-TIGHTENED TO PREVENT DAMAGE OR INJURY. ALWAYS CHECK TO ENSURE THAT ALL HARDWARE IS KEPT TIGHTENED.

Thank you for your purchase