





### Important safety instructions:

- Please read carefully all instructions before assembly.
- For your safety and ease, assembly by two or more adults is recommended.
- Keep instructions for future use.

### Pre-assembly:







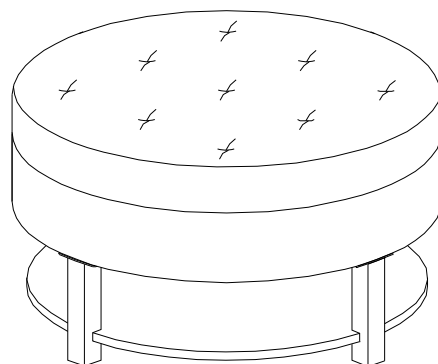

- Do not discard any content until assembly is complete to avoid accidentally discarding small parts or hardware.
- Take out all parts and hardware from box.

### Parts List

Item	Description	QTY
P1	Top Cushion 	1
P2	Storage 	1
P3	Legs 	4
P4	Shelf 	1



### Hardware List

Item	Description	QTY
H1	Long Bolts Ø1/4"x1"L 	8
H2	Medium Bolts Ø1/4"x3/4"L 	4
H3	Short Bolts Ø1/4"x1/2"L 	4
H4	Lock Washers Ø1/4" 	16
H5	Big Flat Washers Ø1/4"x19mm 	8
H6	Small Flat Washers Ø1/4"x12mm 	8
H7	Allen Wrench Ø1/4" 	1
H8	"L" Bracket 	4

### DISCLAIMER:

**WHEN PROPERLY ASSEMBLED, THIS ITEM IS SAFE FOR INTENDED USE. SELLER IS NOT LIABLE FOR ANY DAMAGES RESULTING FROM ITEM BEING IMPROPERLY ASSEMBLED AFTER PURCHASE.**

### Assembly Procedures:

**Step 1.** Assembly the ottoman on a flat, soft surface such as a carpet or cloth to prevent scratching the finish. Attach three legs (P3) to bottom of storage (P2) as shown below.

(H1)x6 Long Bolts Ø1/4"x1"L 

(H4)x6 Lock Washers Ø1/4" 

(H5)x6 Big Flat Washers Ø1/4"x19mm 



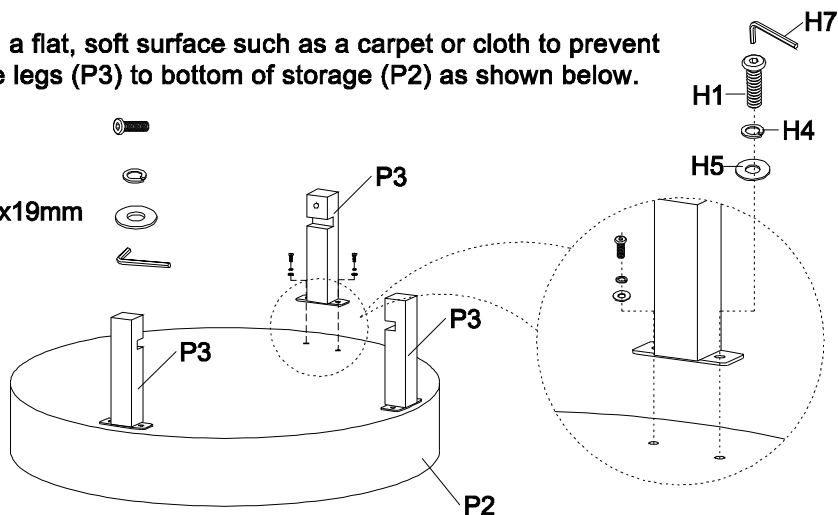

(H7)x1 Allen Wrench Ø1/4" 

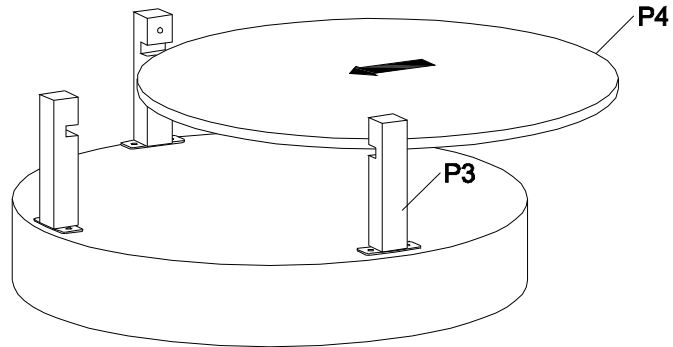

Step 2. Attach the shelf (P4) to the assembled legs (P3) as shown below.







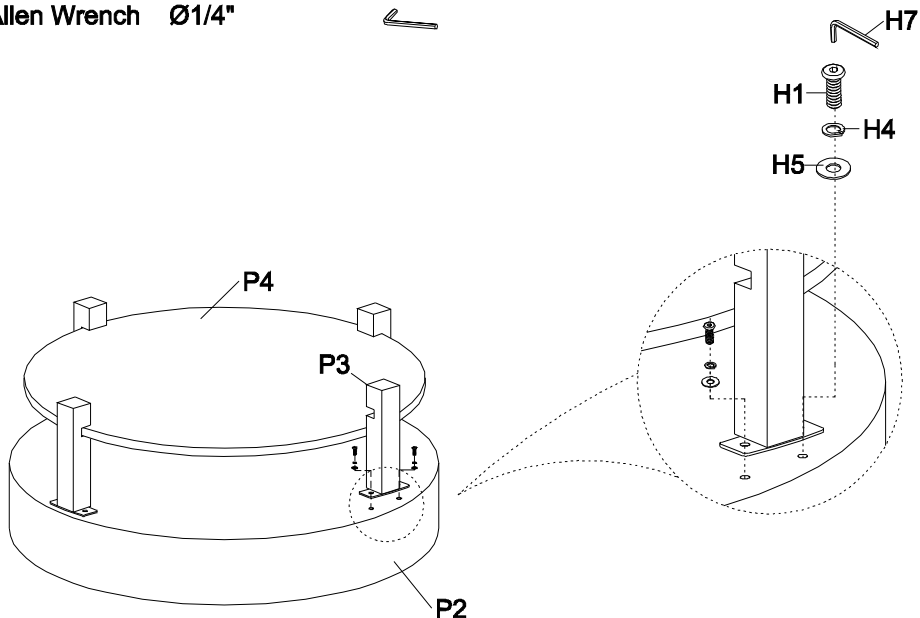

Step 3. Loosely attach last one leg (P3) to the assembled bottom of storage (P2) and shelf (P4) as shown below.

- (H1)x2 Long Bolts  $\text{\O}1/4\text{"x1"}\text{"L}$  
- (H4)x2 Lock Washers  $\text{\O}1/4\text{"}$  
- (H5)x2 Big Flat Washers  $\text{\O}1/4\text{"x19mm}$  
- (H7)x1 Allen Wrench  $\text{\O}1/4\text{"}$  



**Step 4. Attach "L" Bracket (H8) to the shelf (P4) and each leg (P3) as shown below.**

- (H2)x4 Medium Bolts  $\text{Ø}1/4\text{"x}3/4\text{"L}$  
- (H3)x4 Short Bolts  $\text{Ø}1/4\text{"x}1/2\text{"L}$  
- (H4)x8 Lock Washers  $\text{Ø}1/4\text{"}$  
- (H6)x8 Small Flat Washers  $\text{Ø}1/4\text{"x}12\text{mm}$  
- (H7)x1 Allen Wrench  $\text{Ø}1/4\text{"}$  
- (H8)x4 "L" Bracket 

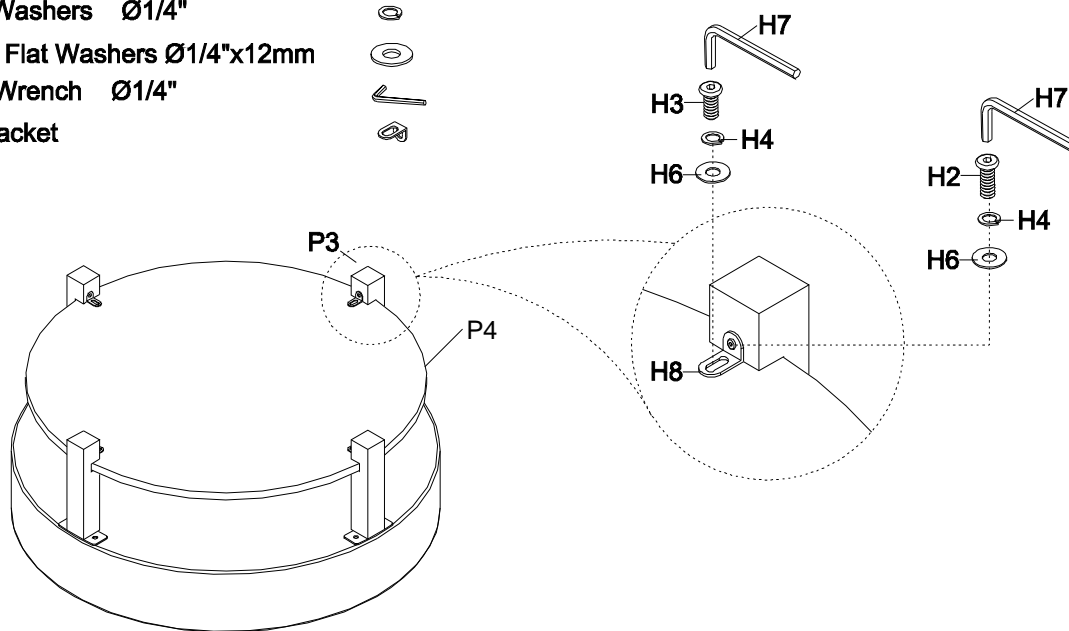

**Step 5.**

- 1) Turn the assembled ottoman to an upright position. Make sure the bottom is level and securely tighten all bolts with Allen wrench (H7).
- 2) Put the top cushion (P1) on the ottoman top.
- 3) Assembly is complete. **Failure to follow these instructions may cause the bolts to misalign during assembly.**

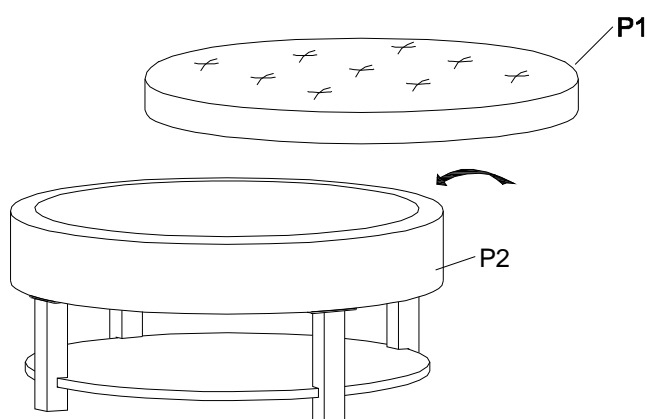

ADDITIONAL NOTE ABOUT SAFETY: BOLTS MAY LOOSEN DURING NORMAL EVERYDAY USE. THEY SHOULD BE PERIODICALLY INSPECTED AND RE-TIGHTENED TO PREVENT DAMAGE OR INJURY. ALWAYS CHECK TO ENSURE THAT ALL HARDWARE IS KEPT TIGHTENED.

**Thank you for your purchase**