









Important safety instructions:

- Please read carefully all instructions before assembly.
- For your safety and ease, assembly by two or more adults is recommended.
- Keep instructions for future use.









Pre-assembly:

- Do not discard any content until assembly is complete to avoid accidentally discarding small parts or hardware.
- Take out all parts and hardware from box.

Parts List

Item	Description	QTY
P1	Chair Top 	1
P2	Left Front Leg  	1
P3	Right Front Leg  	1
P4	Back Legs 	2
P5	Back Stretcher 	1
P6	Front Stretchers 	1

Hardware List

Item	Description	QTY
H1	Long Bolts Ø5/16"x1-3/4"L 	8
H2	Lock Washers 5/16" 	8
H3	Flat Washers 5/16" 	8
H4	Allen Wrench 5/16" 	1
H5	Short Bolts Ø1/4"x1-1/4"L 	2
H6	Lock Washers 1/4" 	2
H7	Flat Washers 1/4" 	2
H8	Allen Wrench 1/4" 	1
H9	Screws #8*1-1/2" 	4

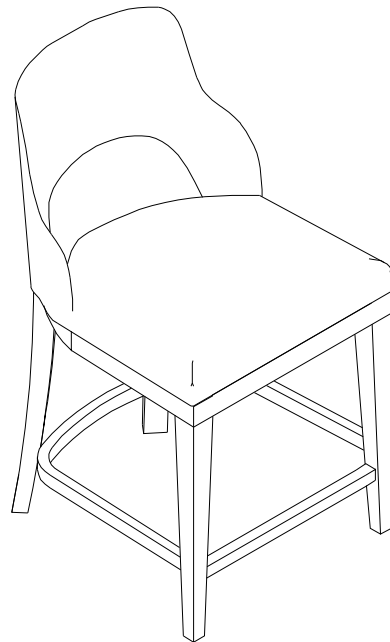





DISCLAIMER:

WHEN PROPERLY ASSEMBLED, THIS ITEM IS SAFE FOR INTENDED USE. SELLER IS NOT LIABLE FOR ANY DAMAGES RESULTING FROM ITEM BEING IMPROPERLY ASSEMBLED AFTER PURCHASE.

Assembly Procedures:

Step 1. Assemble the stool on a flat, soft surface such as a carpet or cloth to prevent scratching the finish. Loosely attach each back leg (P4) to the bottom of chair top (P1) and using long bolts (H1), lock washers (H2) and flat washers (H3) as shown below.

- (H1)x4 Long Bolts 
- (H2)x4 Lock Washers 
- (H3)x4 Flat Washers 
- (H4)x4 Allen Wrench 

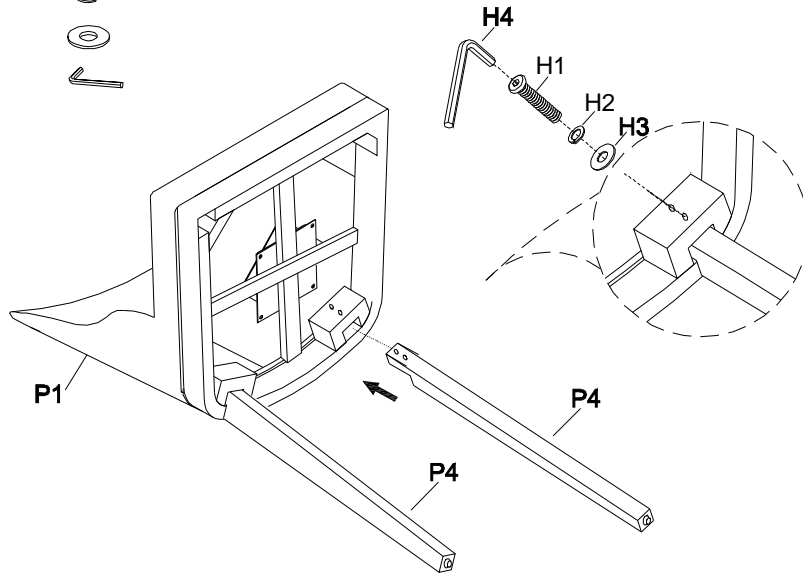

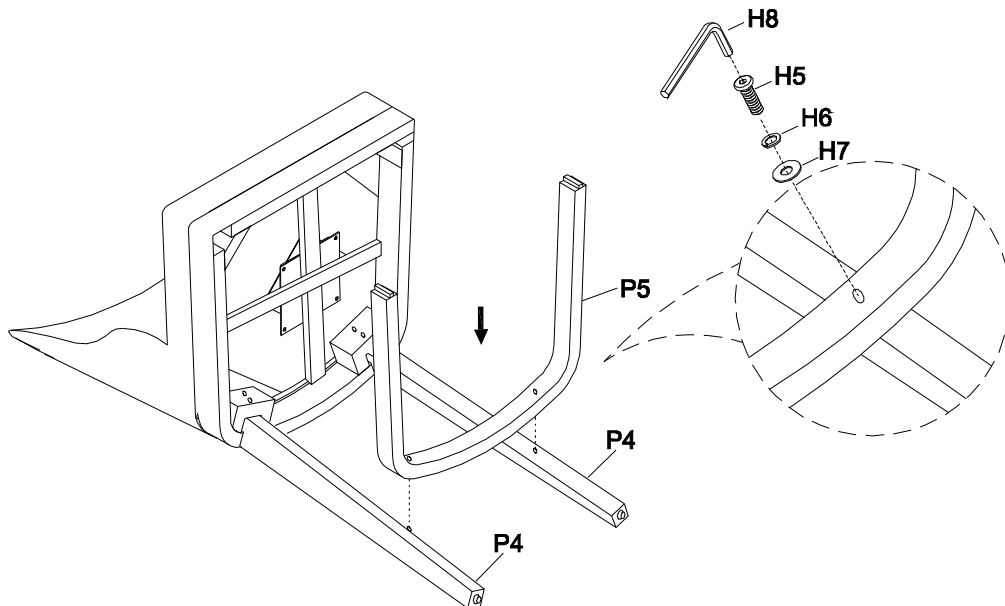

Step 2. Loosely attach back stretcher (P5) to back legs (P4) using short bolts (H5), lock washers (H6) and flat washers (H7) as shown below.

- (H5)x2 Short Bolts 
- (H6)x2 Lock Washers 
- (H7)x2 Flat Washers 
- (H8)x1 Allen Wrench 



Step 3. Attach the left front leg (P2) to the chair top (P1) and back stretcher (P5) using long bolts (H1), lock washers (H2) and flat washers (H3) as shown below.

- (H1)x2 Long Bolts 
- (H2)x2 Lock Washers 
- (H3)x2 Flat Washers 

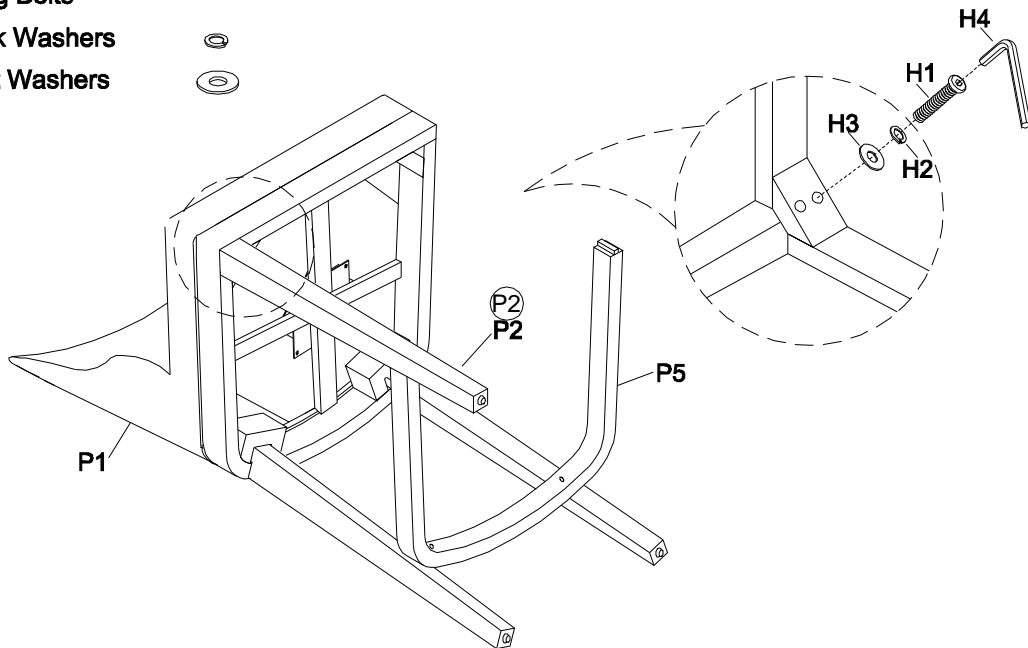

Step 4.

- 1) Insert the front stretcher (P6) to the left front leg (P2), then attach the other the right front leg (P3) to the bottom of chair top (P1) and back stretcher (P5) using bolt (H1), lock washer (H2) and flat washer (H3) as shown below.
- 2) Tighten screws (H9) through the stretchers (P5,P6) to the front legs (P2&P3) with screw driver (not provided).
- 3) Make sure the stool is level on the floor and securely tighten all bolts by Allen wrench (H4 & H8).
- 4) Assembly is complete. **Failure to follow these instructions may cause the bolts to misalign during assembly.**

- (H1)x2 Long Bolts 
- (H2)x2 Lock Washers 
- (H3)x2 Flat Washers 
- (H9)x4 Screws 

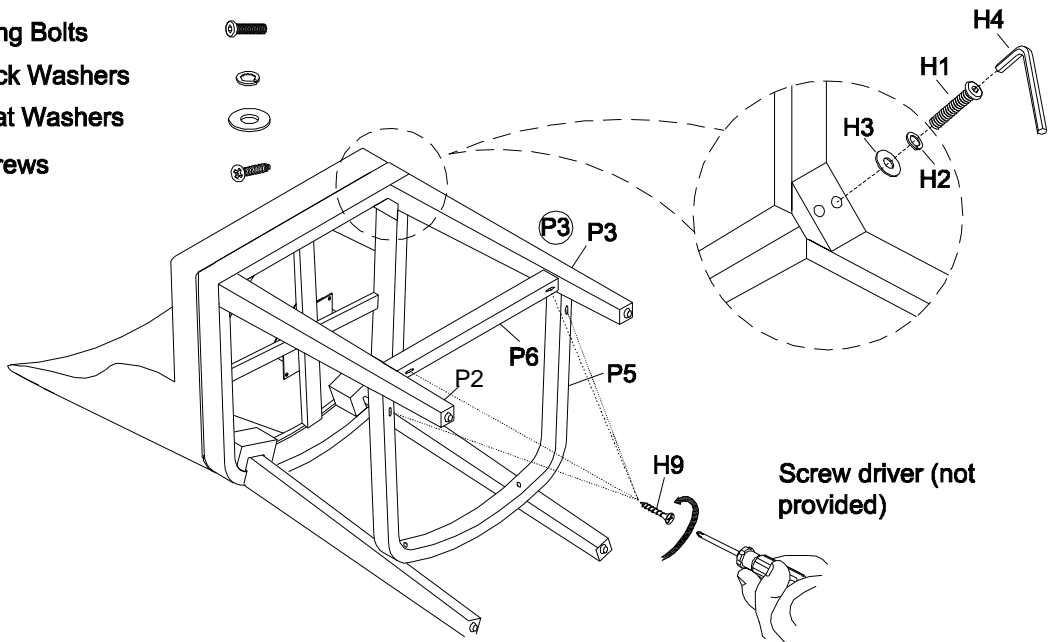

ADDITIONAL NOTE ABOUT SAFETY: BOLTS MAY LOOSEN DURING NORMAL EVERYDAY USE. THEY SHOULD BE PERIODICALLY INSPECTED AND RE-TIGHTENED TO PREVENT DAMAGE OR INJURY. ALWAYS CHECK TO ENSURE THAT ALL HARDWARE IS KEPT TIGHTENED.

Thank you for your purchase