



Important safety instructions:

- Please read carefully all instructions before assembly.
- For your safety and ease, assembly by two or more adults is recommended.
- Keep instructions for future use.







Pre-assembly:

- Do not discard any content until assembly is complete to avoid accidentally discarding small parts or hardware.
- Take out all parts and hardware from box.

Parts List

Item	Description	QTY
P1	Chair Back 	1
P2	Seat Cushion 	1
P3	Front Legs 	2

Hardware List

Item	Description	QTY
H1	Long Bolts $\phi 5/16$ "*3-1/4"L 	4
H2	Medium Bolts $\phi 5/16$ "*2"L 	4
H3	Short Bolts $\phi 5/16$ "*1-3/4" 	1
H4	Lock Washers $\phi 5/16$ " 	9
H5	Flat washers $\phi 5/16$ " 	9
H6	Allen Wrench $\phi 5/16$ " 	1

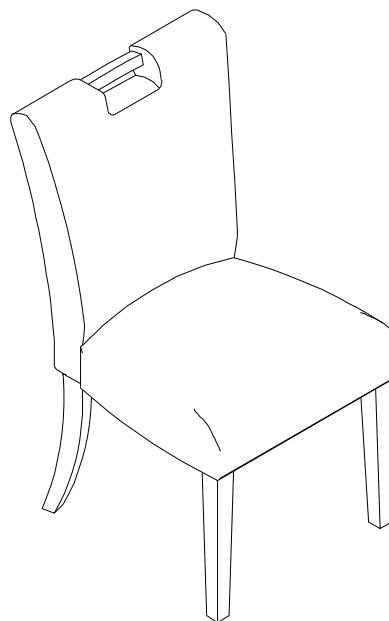

DISCLAIMER:

WHEN PROPERLY ASSEMBLED, THIS ITEM IS SAFE FOR INTENDED USE. SELLER IS NOT LIABLE FOR ANY DAMAGES RESULTING FROM ITEM BEING IMPROPERLY ASSEMBLED AFTER PURCHASE.



Assembly Procedures:

Step 1. Assembly the chair on a flat, soft surface such as a carpet or cloth to prevent scratching the finish. Open the bottom covering, then loosely attach seat cushion (P2) to a chair back (P1) using long / short bolts (H1, H3), lock washers (H4) and flat washers (H5) as shown below.

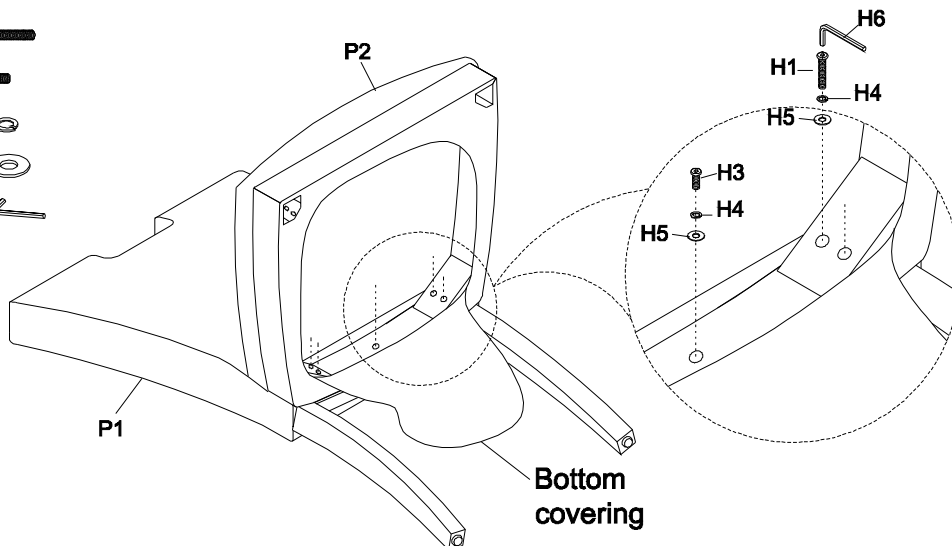
- (H1)x4 Long Bolts 
- (H3)x1 Short Bolts 
- (H4)x5 Lock Washers 
- (H5)x5 Flat washers 
- (H6)x1 Allen Wrench 



Step 2. Attach each front leg (P3) to seat cushion (P2) using medium bolts (H2), lock washers (H4) and flat washers (H5) as shown below.

- | | | |
|--------|--------------|---|
| (H2)x4 | Medium Bolts |  |
| (H4)x4 | Lock Washers |  |
| (H5)x4 | Flat washers |  |

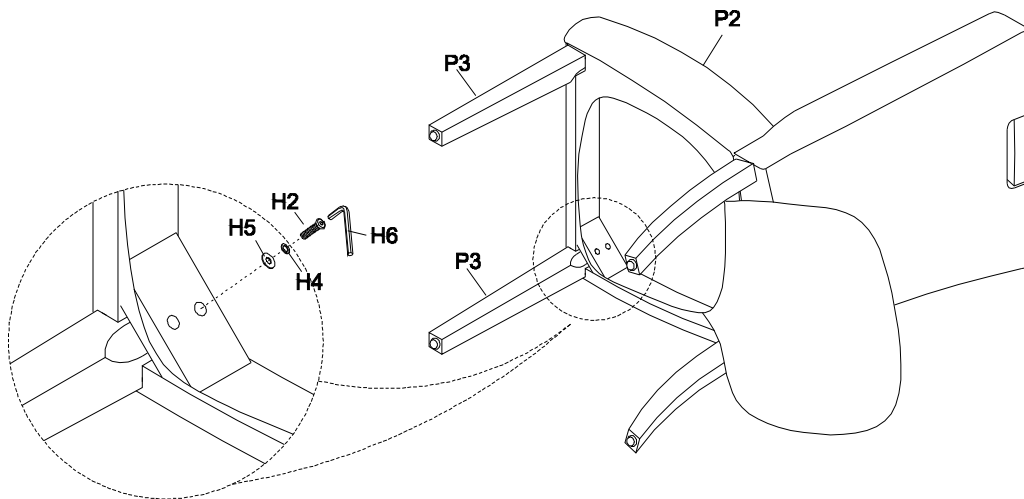

Step 3.

- 1) Make sure the chair is level and securely tighten all the bolts with Allen wrench (H6).
- 2) Assembly is complete. **Failure to follow these instructions may cause the bolts to misalign during assembly.**

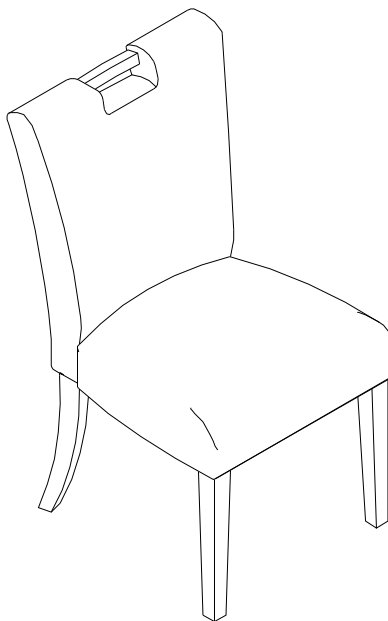

ADDITIONAL NOTE ABOUT SAFETY: BOLTS MAY LOOSEN DURING NORMAL EVERYDAY USE. THEY SHOULD BE PERIODICALLY INSPECTED AND RE-TIGHTENED TO PREVENT DAMAGE OR INJURY. ALWAYS CHECK TO ENSURE THAT ALL HARDWARE IS KEPT TIGHTENED.

Thank you for your purchase