



### Important safety instructions:

- Please read carefully all instructions before assembly.
- For your safety and ease, assembly by two or more adults is recommended.
- Keep instructions for future use.

### Pre-assembly:

- Do not discard any content until assembly is complete to avoid accidentally discarding small parts or hardware.
- Take out all parts and hardware from box.

### Parts List

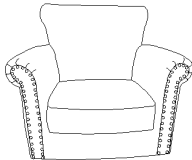
Item	Description	QTY
P1	FRONT LEGS 	2
P2	BACK LEG 	2
P3	PLASTIC WASHER 	4
P4	CHAIR 	1

### DISCLAIMER:

**WHEN PROPERLY ASSEMBLED, THIS ITEM IS SAFE FOR INTENDED USE. SELLER IS NOT LIABLE FOR ANY DAMAGES RESULTING FROM ITEM BEING IMPROPERLY ASSEMBLED AFTER PURCHASE.**

### Assembly Procedures:

**Step 1:** Assemble the chair on a flat and soft surface either on a carpet or cloth to prevent the finish from scratching. To locate the hardware, please turn the chair upside down, you will find the components beneath the fabric cover that is secured by zipper underneath the seat cushion. Legs and hardware box could be located beneath the fabric cover.

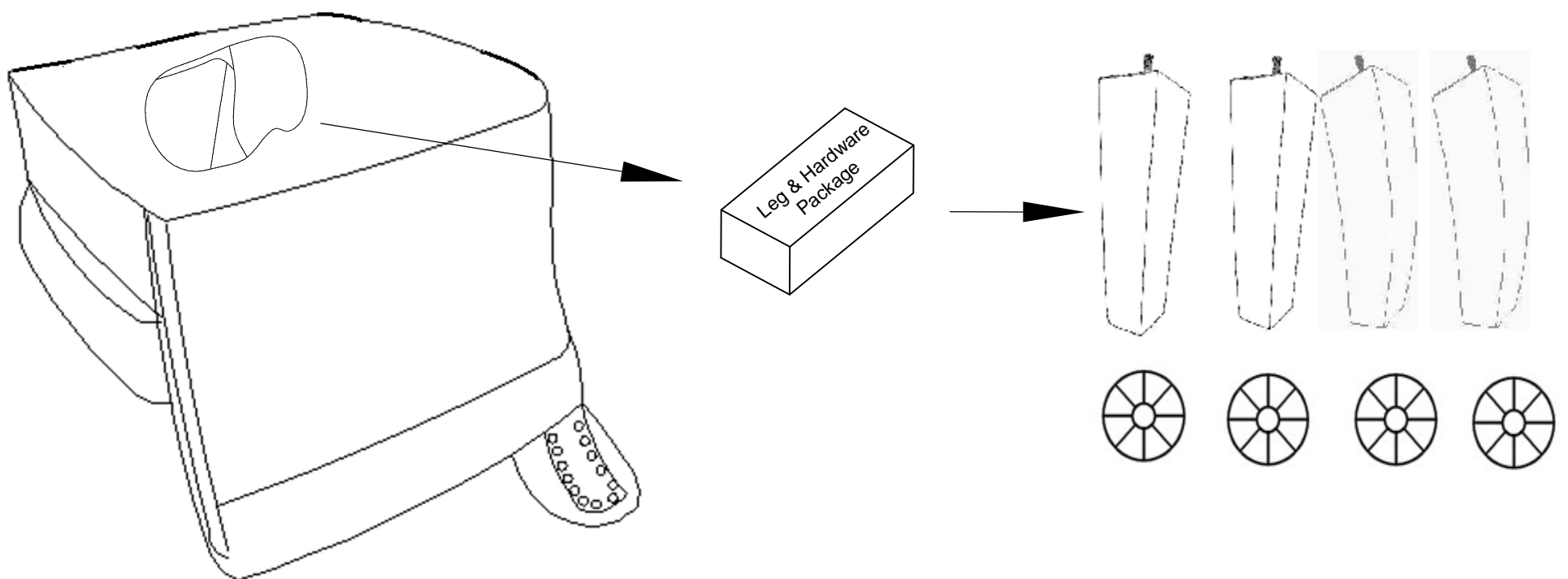

**Step 2:** Attach front legs (P1), back legs (P2) into the holes on the bottom of chair top (P4) through plastic washer (P3). Screw tight to the right angle:

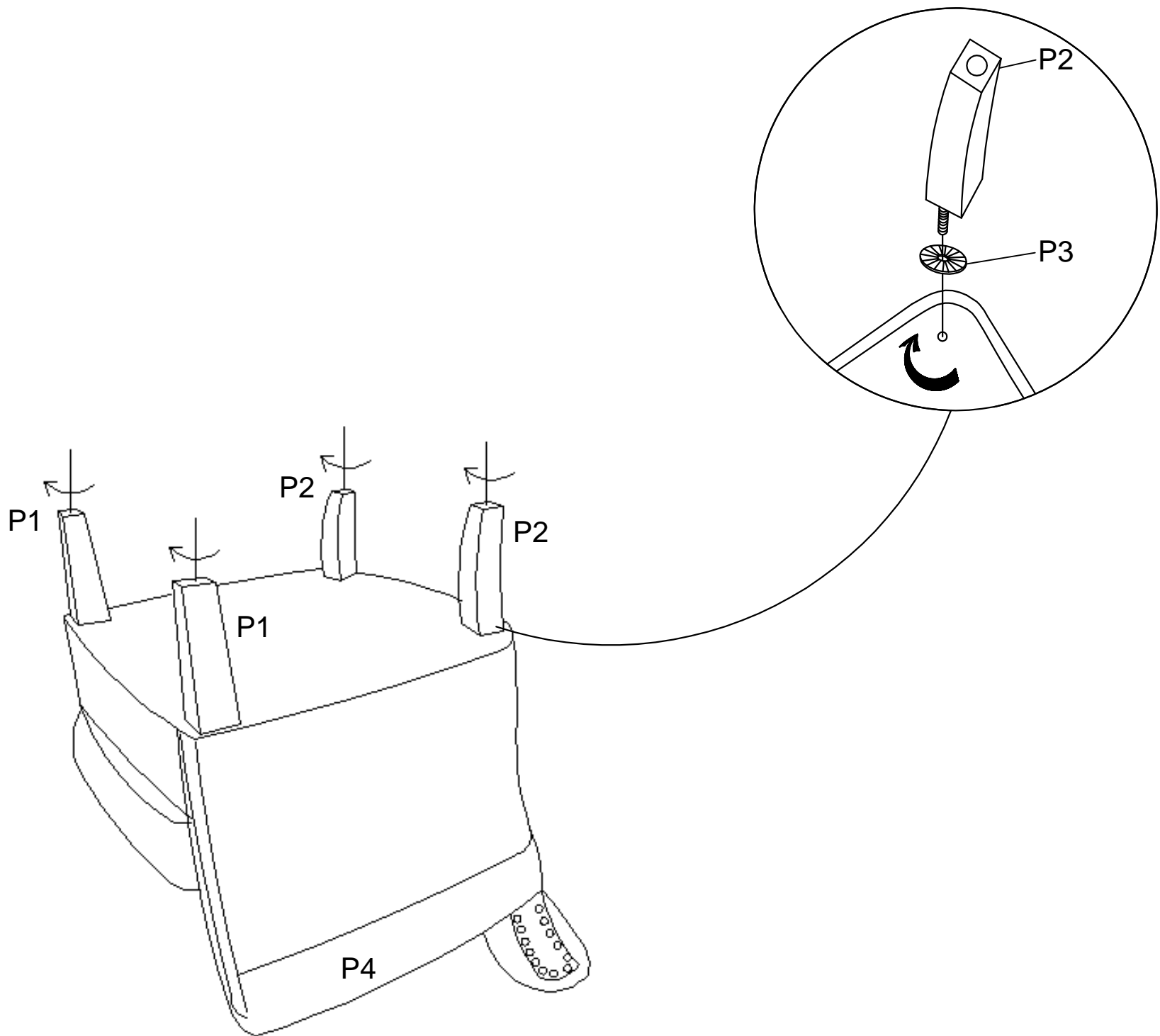

**Step 3:** Turn the chair over and place it upright on a level surface. Assembly is complete.

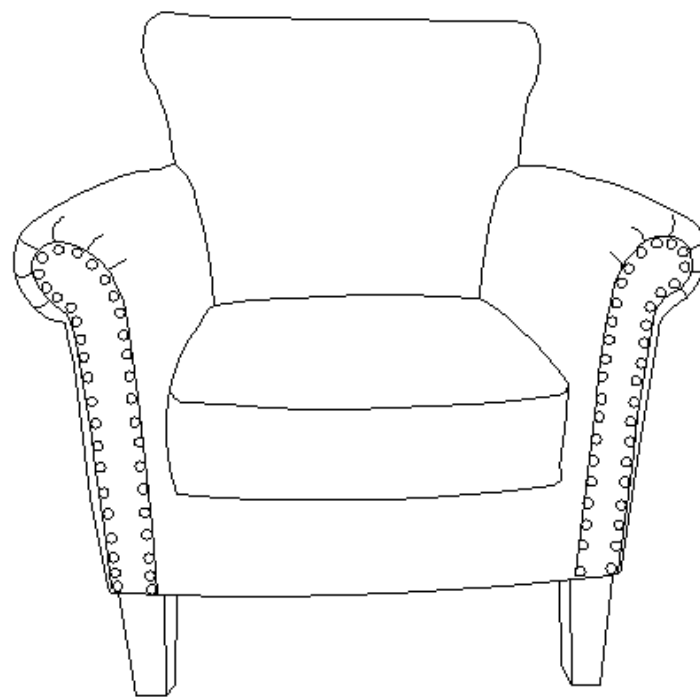

**ADDITIONAL NOTE ABOUT SAFETY: BOLTS MAY LOOSEN DURING NORMAL EVERYDAY USE. THEY SHOULD BE PERIODICALLY INSPECTED AND RE-TIGHTENED TO PREVENT DAMAGE OR INJURY. ALWAYS CHECK TO ENSURE THAT ALL HARDWARE IS KEPT TIGHTENED.**

Thank you for your purchase