





**Important safety instructions:**

- Please read carefully all instructions before assembly.
- For your safety and ease, assembly by two or more adults is recommended.
- Keep instructions for future use.

**Pre-assembly:**

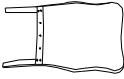

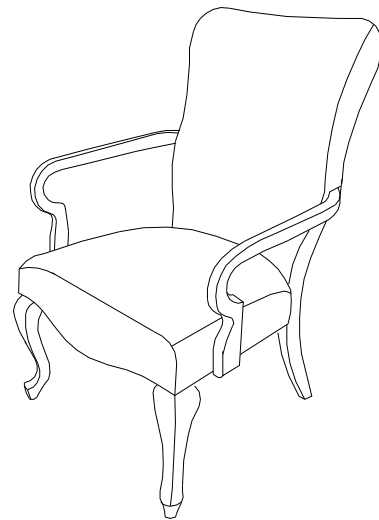

- Do not discard any content until assembly is complete to avoid accidentally discarding small parts or hardware.
- Take out all parts and hardware from box.

**Parts List**

Item	Description	QTY
P1	Chair Back 	1
P2	Front legs 	2
P3	Left Arm 	1
P4	Right Arm 	1
P5	Seat Cushion 	1



**Hardware List**

Item	Description	QTY
H1	Short Bolts Ø5/16"×2"L 	9
H2	Long Bolts Ø5/16"×2-1/4"L 	4
H3	Lock Washers 5/16" 	13
H4	Flat Washers 5/16"×3/4" 	13
H5	Allen Wrench 5/16" 	1
H6	Screws 8#×1-1/2"L 	2





**DISCLAIMER:**

WHEN PROPERLY ASSEMBLED, THIS ITEM IS SAFE FOR INTENDED USE. SELLER IS NOT LIABLE FOR ANY DAMAGES RESULTING FROM ITEM BEING IMPROPERLY ASSEMBLED AFTER PURCHASE.

**Assembly Procedures:**



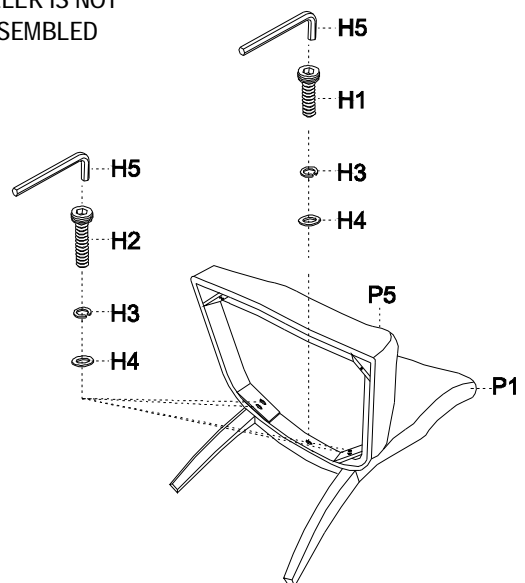

**Step 1: Assemble the chair on a flat, soft surface such as a carpet or cloth to prevent scratching the finish.**

**Attach the seat cushion (P5) to the legs of chair back (P1) as shown below.**

- (H1)x1 Short Bolts Ø5/16"×2"L 
- (H2)x4 Long Bolts Ø5/16"×2-1/4"L 
- (H3)x5 Lock Washers 5/16" 
- (H4)x5 Flat Washers 5/16"×3/4" 
- (H5)x1 Allen Wrench 5/16" 



**Step 2: Attach the front legs (P2) to the seat cushion (P5) as shown below.**

- (H1)x4 Short Bolts  $\text{Ø}5/16'' \times 2''$  L 
- (H3)x4 Lock Washers 5/16" 
- (H4)x4 Flat Washers 5/16'' $\times 3/4''$  
- (H5)x1 Allen Wrench 5/16" 

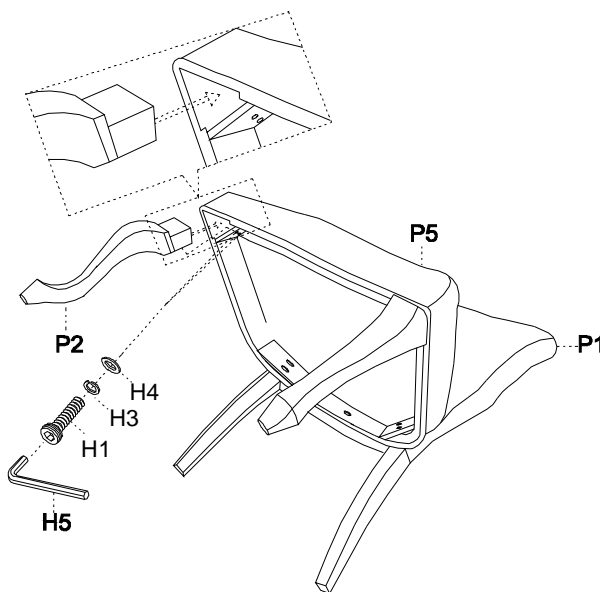

**Step 3: Turn the assembled chair to an upright position. Attach the left arm (P3) and right arm (P4) to the seat cushion (P5) and chair back (P1) as shown below. Make sure the chair is level and securely tighten all bolts with Allen wrench (H5). Assembly is complete. Failure to follow these instructions may cause the bolts to misalign during assembly.**

- (H1)x4 Short Bolts  $\text{Ø}5/16'' \times 2''$  L 
- (H3)x4 Lock Washers 5/16" 
- (H4)x4 Flat Washers 5/16'' $\times 3/4''$  
- (H5)x1 Allen Wrench 5/16" 
- (H6)x2 Screws 8# $\times 1-1/2''$  L 

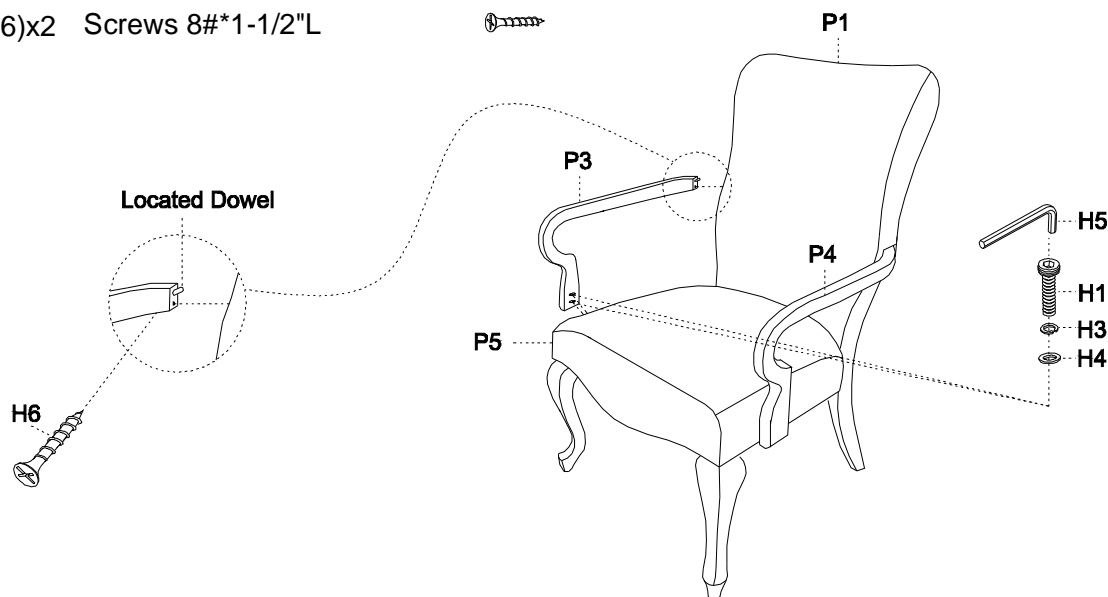

**ADDITIONAL NOTE ABOUT SAFETY: BOLTS MAY LOOSEN DURING NORMAL EVERYDAY USE. THEY SHOULD BE PERIODICALLY INSPECTED AND RE-TIGHTENED TO PREVENT DAMAGE OR INJURY. ALWAYS CHECK TO ENSURE THAT ALL HARDWARE IS KEPT TIGHTENED.**

**Thank you for your purchase**