

MADISONPARK® ASSEMBLY INSTRUCTIONS

Description: Christine Counter Stool





Important safety instructions:

- Please read carefully all instructions before assembly.
- For your safety and ease, assembly by two or more adults is recommended.
- Keep instructions for future use.

Pre-assembly:

- Do not discard any content until assembly is complete to avoid accidentally discarding small parts or hardware.
- Take out all parts and hardware from box.

Parts List

Item	Description	QTY
P1	Seat Cushion 	1
P2	Long Post 	4
P3	Short Post 	4
P4	Foot Frame 	1

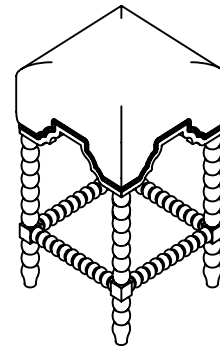

DISCLAIMER:

WHEN PROPERLY ASSEMBLED, THIS ITEM IS SAFE FOR INTENDED USE. SELLER IS NOT LIABLE FOR ANY DAMAGES RESULTING FROM ITEM BEING IMPROPERLY ASSEMBLED AFTER PURCHASE.

Assembly Procedures:

Step 1. Turn over the cushion (P1) on a flat, soft surface such as a carpet or cloth to prevent scratching the finish. Attach long posts (P2) to the bottom of seat cushion (P1) as shown below image 1.

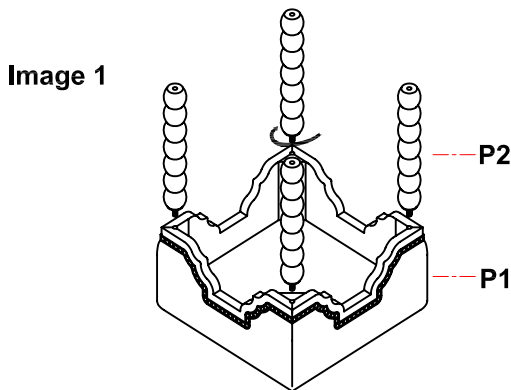

Step 2. Attach the foot frame (P4) onto the bottom of long posts (P2), then attached the short post (P3) onto the foot frame (P4) as shown below image 2.

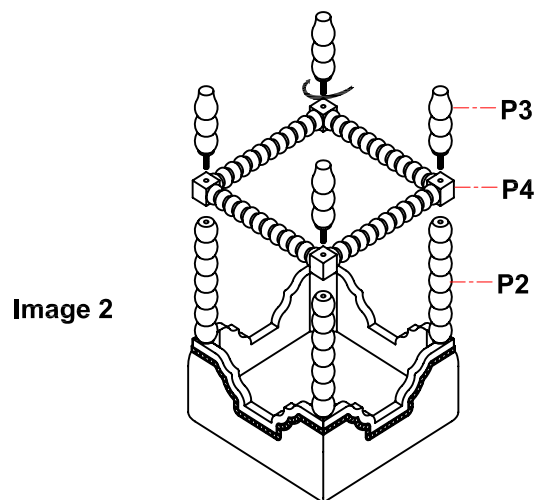

ADDITIONAL NOTE ABOUT SAFETY: BOLTS MAY LOOSEN DURING NORMAL EVERYDAY USE. THEY SHOULD BE PERIODICALLY INSPECTED AND RE-TIGHTENED TO PREVENT DAMAGE OR INJURY. ALWAYS CHECK TO ENSURE THAT ALL HARDWARE IS KEPT TIGHTENED.

Thank you for your purchase