





Important safety instructions:

- Please read carefully all instructions before assembly.
- For your safety and ease, assembly by two or more adults is recommended.
- Keep instructions for future use.





Pre-assembly:

- Do not discard any content until assembly is complete to avoid accidentally discarding small parts or hardware.
- Take out all parts and hardware from box.

Parts List

Item	Description	QTY
P1	Chair Top 	1
P2	Front Legs 	2
P3	Right Back Leg  (P3)	1
P4	Left Back Leg  (P4)	1

Hardware List

Item	Description	QTY
H1	Bolts Ø5/16"*2-1/4" 	4
H2	Bolts Ø5/16"*2-3/4" 	4
H3	Lock Washers 5/16" 	8
H4	Flat Washers 5/16" 	8
H5	Allen Wrench 5/16" 	1

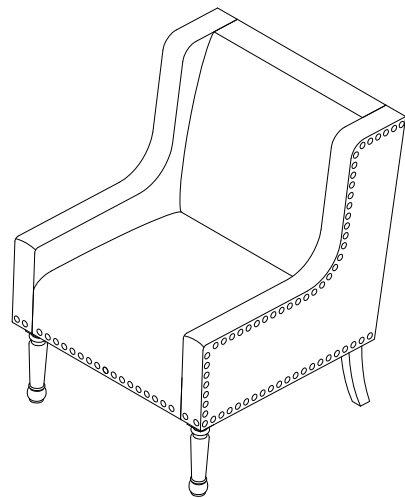

DISCLAIMER:

WHEN PROPERLY ASSEMBLED, THIS ITEM IS SAFE FOR INTENDED USE. SELLER IS NOT LIABLE FOR ANY DAMAGES RESULTING FROM ITEM BEING IMPROPERLY ASSEMBLED AFTER PURCHASE.

Assembly Procedures:

Step 1. Assembly the chair on a flat, soft surface such as a carpet or cloth to prevent scratching the finish.

- 1) Open the bottom covering of the chair top (P1).
- 2) Loosely attach the front/back legs (P2, P3,P4) to the chair top (P1) following the label "P3" "P4" on the left/right back leg accordingly and using bolts (H1,H2), lock washers (H3), flat washers (H4) as shown below.
- 3) Turn the assembled chair to an upright position. Make sure the chair is level and securely tighten all bolts with Allen wrench (H5). Close the bottom covering on the bottom of chair top (P1).
- 4) Assembly is complete. **Failure to follow these instructions may cause the bolts to misalign during assembly.**

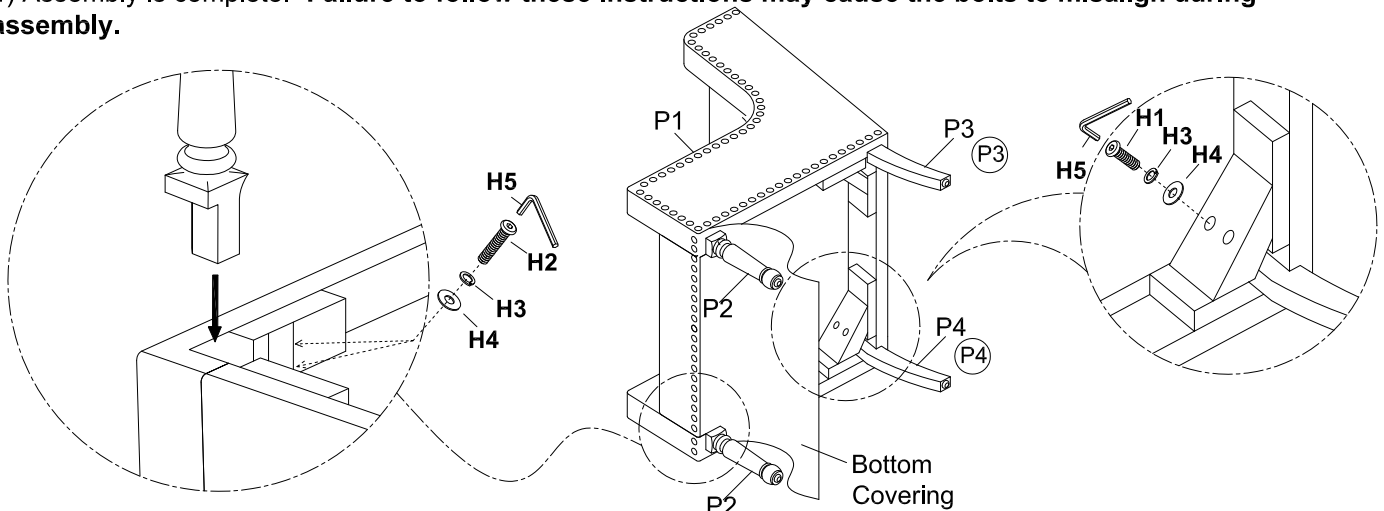

ADDITIONAL NOTE ABOUT SAFETY: BOLTS MAY LOOSEN DURING NORMAL EVERYDAY USE. THEY SHOULD BE PERIODICALLY INSPECTED AND RE-TIGHTENED TO PREVENT DAMAGE OR INJURY. ALWAYS CHECK TO ENSURE THAT ALL HARDWARE IS KEPT TIGHTENED.

Thank you for your purchase