

# HARBOR HOUSE® ASSEMBLY INSTRUCTIONS

HH115-0031A/0031B/0031C Montclair King Bed





## Important safety instructions:

- Please carefully read all instructions before assembling.
- For your safety and ease, assembly by two or more adults is recommended.
- Keep instructions for future use.







## Pre-assembly:

- Do not discard any contents until after assembly is complete to avoid accidentally discarding small parts or hardware.
- Remove all parts and hardware from box along with any plastic protective packaging.
- Check for damaged or missing parts. Call customer service 1-888-485-2224 to order missing supplies.

## Parts List

Item	Description	QTY
P1	Headboard 	1
P2	Footboard 	1
P3	Rail 	2
P4	Slat 	5
P5	Support Leg 	6

## Hardware List

Item	Description	QTY
H1	Bolts Ø5/16"x3"L 	8
H2	Spring Washers Ø5/16" 	8
H3	Half Moon Washers Ø5/16" 	8
H4	Nut Ø5/16" 	8
H5	Open Wrench Ø5/16" 	1
H6	Screw #8*1-1/4" 	10

## Tools needed (Not included)

Hammer

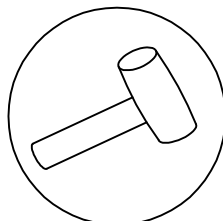



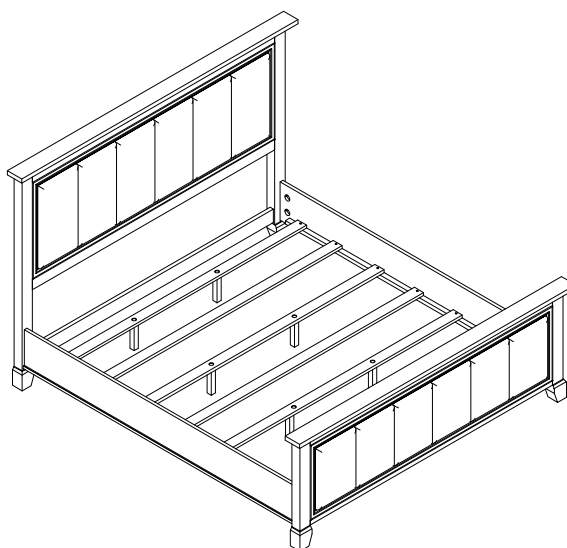
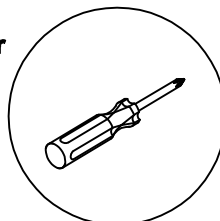

Screwdriver



### Assembly Procedures:

Step 1. Attach the rails (P3) to headboard (P1) and footboard (P2) using bolts (H1), half moon washers (H3), spring washers (H2), nut (H4) and open wrench (H5) as shown below.

- (H1)x8 Bolts 
- (H2)x8 Spring Washers 
- (H3)x8 Half Moon Washers 
- (H4)x8 Nut 
- (H5)x1 Open Wrench 

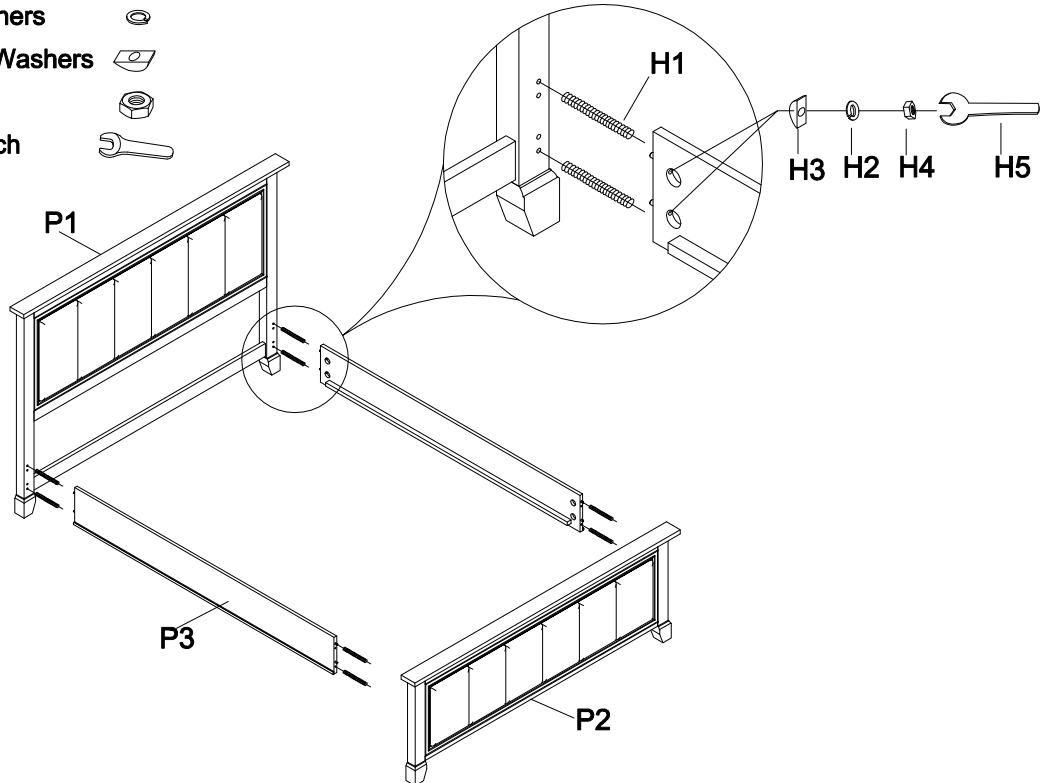

### Step 2.

- 1) Attach the support legs (P5) to slats (P4).
- 2) Attach the slats (P4) to side rails (P3), as shown below.

- (H6)x10 Screw #8\*1-1/4" 

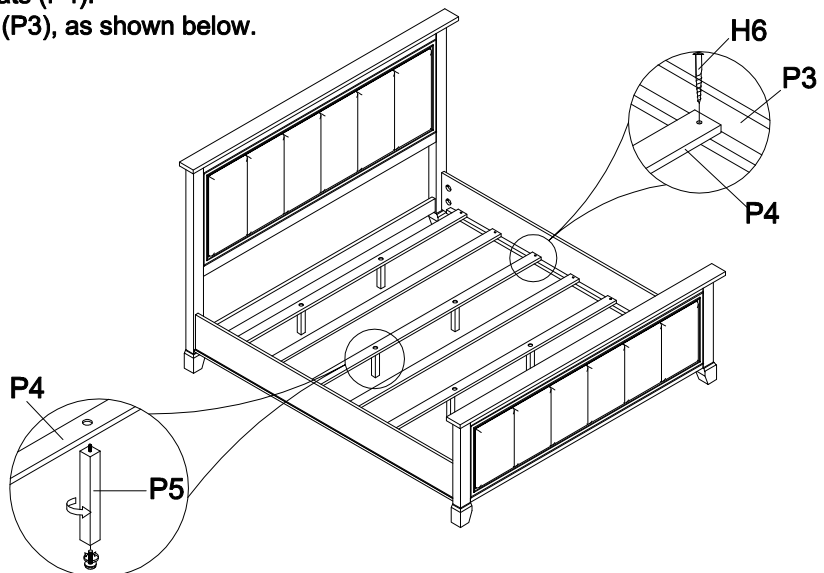

Tightened and keep leveler flat with the floor

### Care Instructions:

- Dust often using a clean ,soft ,dry and lint-free cloth.
- Blot spills immediately and wipe with a clean ,damp ,cloth.
- We do not recommend the use of chemical cleansers ,abrasives or furniture polish on our lacquered finish.
- Hardware may loosen over time .Periodically check to make sure all connections are tight. Re-tighten if necessary.

Thank you for your purchase

[www.ollix.com](http://www.ollix.com)

Page 2 of 2