





Important safety instructions:

- Please read carefully all instructions before assembly.
- For your safety and ease, assembly by two or more adults is recommended.
- Keep instructions for future use.





Pre-assembly:

- Do not discard any content until assembly is complete to avoid accidentally discarding small parts or hardware.
- Take out all parts and hardware from box.

Parts List

Item	Description	QTY
P1	Chair Top 	1
P2	Left Front Leg  (P2)	1
P3	Right Front Leg  (P3)	1
P4	Back Legs 	2

Hardware List

Item	Description	QTY
H1	Short Bolts Ø5/16"×2"L 	4
H2	Long Bolts Ø5/16"×2-1/2"L 	4
H3	Lock Washers 5/16" 	8
H4	Flat Washers 5/16" 	8
H5	Allen Wrench 5/16" 	1

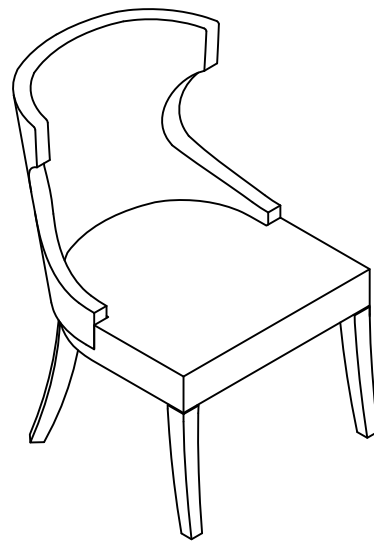

DISCLAIMER:

WHEN PROPERLY ASSEMBLED, THIS ITEM IS SAFE FOR INTENDED USE. SELLER IS NOT LIABLE FOR ANY DAMAGES RESULTING FROM ITEM BEING IMPROPERLY ASSEMBLED AFTER PURCHASE.

Assembly Procedures:

Step 1. Assemble the chair on a flat, soft surface such as a carpet or cloth to prevent scratching the finish.

- 1) Attach left front leg (P2) and right front leg (P3) and back legs (P4) to chair top (P1) following the labels "P2", "P3" on front legs as shown below.
- 2) Make sure the chair is level and securely tighten all bolts with Allen wrench (H4).
- 3) Assembly is complete. **Failure to follow these instructions may cause the bolts to misalign during assembly.**

- (H1)x4 Short Bolts Ø5/16"×2" L 
- (H2)x4 Long Bolts Ø5/16"×2-1/2" L 
- (H3)x8 Lock Washers 
- (H4)x8 Flat Washers 
- (H5)x1 Allen Wrench 

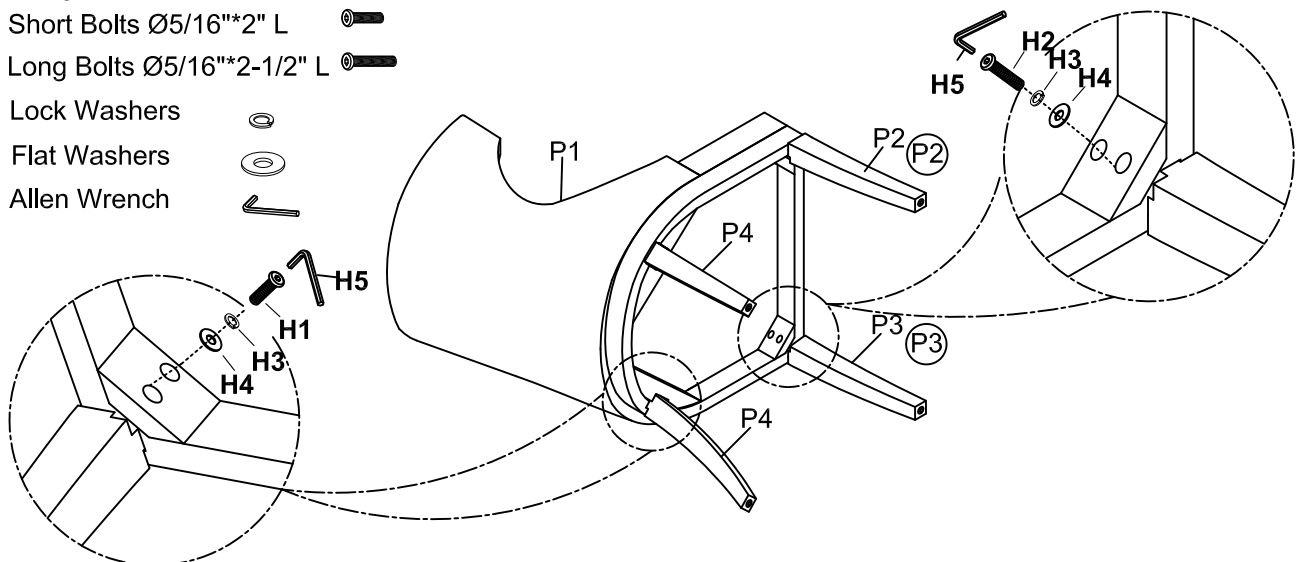

ADDITIONAL NOTE ABOUT SAFETY: BOLTS MAY LOOSEN DURING NORMAL EVERYDAY USE. THEY SHOULD BE PERIODICALLY INSPECTED AND RE-TIGHTENED TO PREVENT DAMAGE OR INJURY. ALWAYS CHECK TO ENSURE THAT ALL HARDWARE IS KEPT TIGHTENED.

Thank you for your purchase