

# MADISONPARK® ASSEMBLY INSTRUCTIONS

Description: Lexi Accent Table



## Important safety instructions:

- Please carefully read all instructions before assembling the table.
- For your safety and ease, assembly by two or more adults is recommended.
- Keep instructions for future use.





## Pre-assembly:

- Do not discard any contents until after assembly is complete to avoid accidentally discarding small parts or hardware.
- Remove all parts and hardware from box along with any plastic protective packaging.

## Parts List

Item	Description	QTY
P1	Top Panel 	1
P2	Post 	1
P3	Base 	1

## Hardware List

Item	Description	QTY
H1	Bolts Ø5/16"*1-3/8"L 	3
H2	Bolts Ø5/16*2"L 	4
H3	Lock Washer Ø5/16" 	7
H4	Flat Washer Ø5/16" 	7
H5	Allen Wrench 5/16" 	1

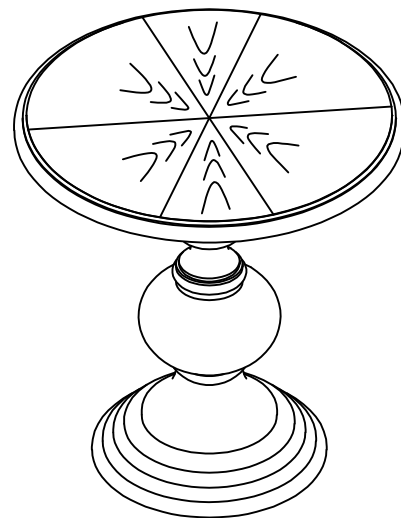





## DISCLAIMER:

**WHEN PROPERLY ASSEMBLED, THIS ITEM IS SAFE FOR INTENDED USE. SELLER IS NOT LIABLE FOR ANY DAMAGES RESULTING FROM ITEM BEING IMPROPERLY ASSEMBLED AFTER PURCHASE.**



## Assembly Procedures:

Step 1. Assemble the table on a flat, soft surface such as a carpet or cloth to prevent scratching the finish. Attach the base (P3) to the post (P2) using bolts (H2), lock washers (H3) and flat washers (H4) as shown below.

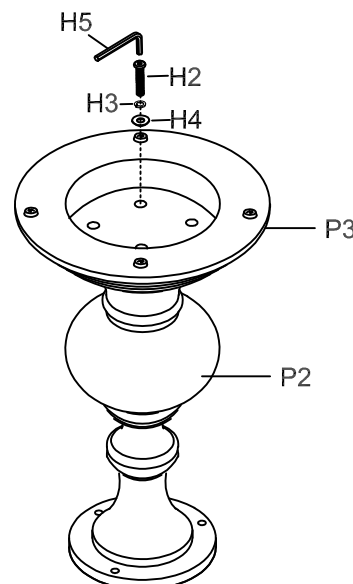
- (H2)x4 Bolts Ø5/16\*2"L 
- (H3)x4 Lock Washer Ø5/16" 
- (H4)x4 Flat Washer Ø5/16" 
- (H5)x1 Allen Wrench 5/16" 



Step 2. Loosely attach assembled post (P2) and base (P3) to the bottom of top panel using bolts (H1), lock washers (H3) and flat washers (H4) as shown below.

- |        |   |   |
|--------|---|---|
| (H1)x3 | Bolts $\varnothing 5/16'' \times 1-3/8''$ L |  |
| (H3)x3 | Lock Washer $\varnothing 5/16''$            |  |
| (H4)x3 | Flat Washer $\varnothing 5/16''$            |  |

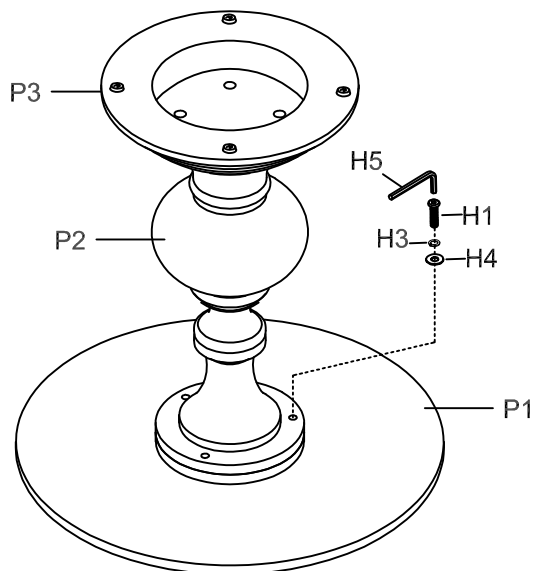

Step 3.

- 1) Securely tighten all the bolts with open wrench (H5).
- 2) Turn the assembled table to an upright position.
- 3) Assembly is complete. Failure to follow these instructions may cause the bolts to misalign during assembly.

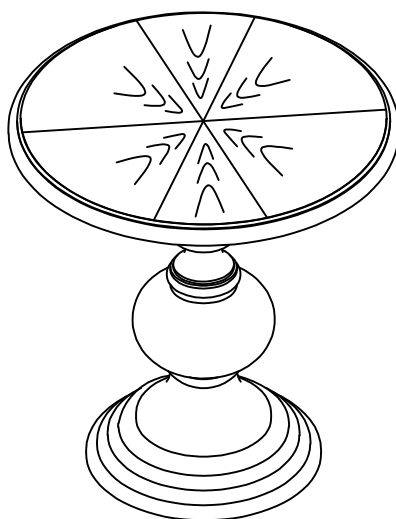

ADDITIONAL NOTE ABOUT SAFETY: BOLTS MAY LOOSEN DURING NORMAL EVERYDAY USE. THEY SHOULD BE PERIODICALLY INSPECTED AND RE-TIGHTENED TO PREVENT DAMAGE OR INJURY. ALWAYS CHECK TO BE SURE THAT ALL HARDWARE IS KEPT TIGHTENED.

Thank you for your purchase