



ASSEMBLY INSTRUCTIONS

Description: TRISTAN RECTANGULAR DINING TABLE





Important safety instructions:

- Please read carefully all instructions before assembly.
- For your safety and ease, assembly by two or more adults is recommended.
- Keep instructions for future use.



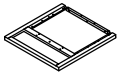
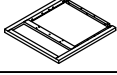

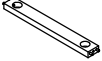
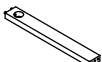





Pre-assembly:

- Do not discard any content until assembly is complete to avoid accidentally discarding small parts or hardware.
- Take out all parts and hardware from box.

Parts List

Item	Description		QTY
P1	Table Top A		1
P2	Table Top B		1
P3	Leg Frames		2
P4	Bases		2
P5	Stretcher A		1
P6	Stretcher B		1
P7	Support Rails		2

Hardware List

Item	Description		QTY
H1	Bolts 5/16" x 2"		21
H2	Bolts 5/16" x 3"		8
H3	Wood Dowel 5/16" x 1-3/4"		4
H4	Hanger Bolt 5/16"x 3-1/4"		3
H5	Curve Washers 5/16"		3
H6	Nut 5/16"		3
H7	Lock Washers 5/16"		29
H8	Flat Washers 5/16"		29
H9	Allen Key		1
H10	Wrench		1





DISCLAIMER:

WHEN PROPERLY ASSEMBLED, THIS ITEM IS SAFE FOR INTENDED USE. SELLER IS NOT LIABLE FOR ANY DAMAGES RESULTING FROM ITEM BEING IMPROPERLY ASSEMBLED AFTER PURCHASE.

Assembly Procedures:



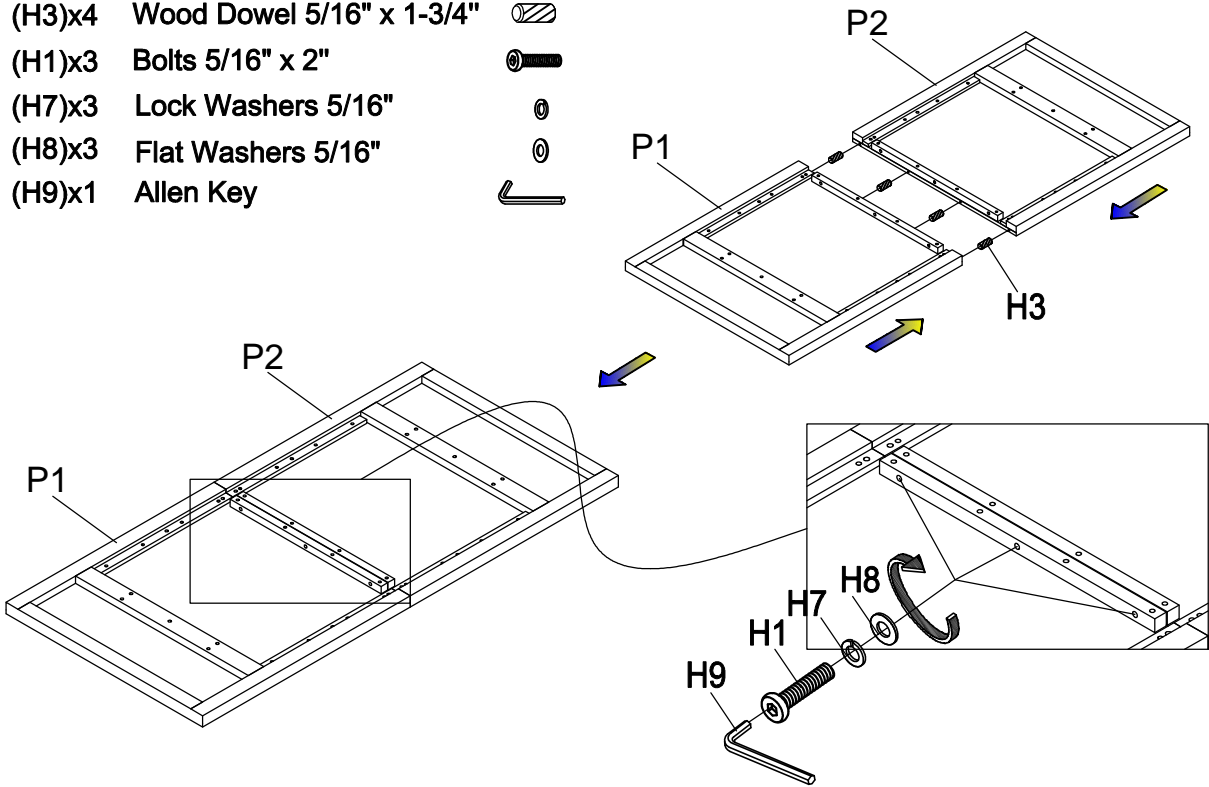

*Assemble the table on a flat, soft surface such as a carpet or cloth to prevent scratching the finish.

Step 1: Attach the Table Top A (P1) to the Table Top B (P2) as shown below.

- (H3)x4 Wood Dowel 5/16" x 1-3/4" 
- (H1)x3 Bolts 5/16" x 2" 
- (H7)x3 Lock Washers 5/16" 
- (H8)x3 Flat Washers 5/16" 
- (H9)x1 Allen Key 





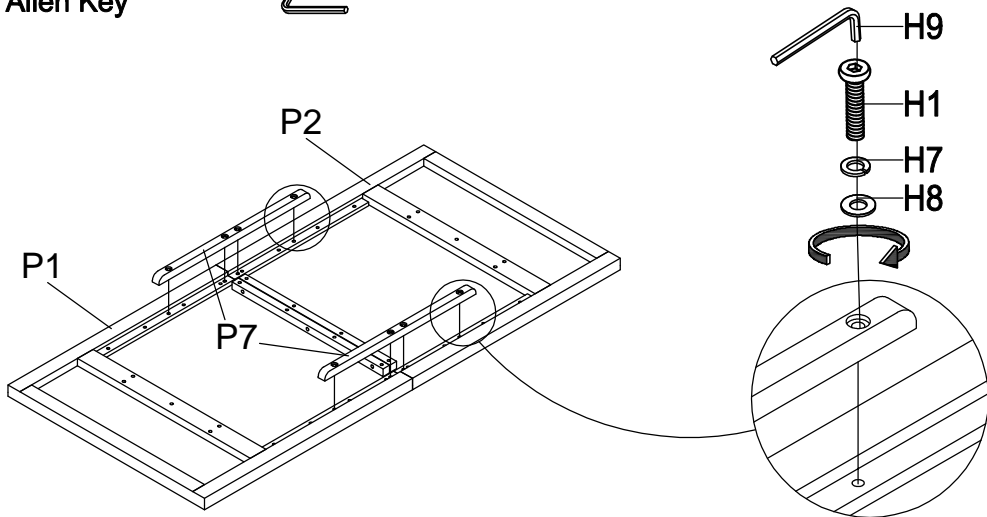

Step 2: Attach the Support Rail (P7) to the Table Top (P1) & (P2) as shown below.

- (H1)x8 Bolts 5/16" x 2" 
- (H7)x8 Lock Washers 5/16" 
- (H8)x8 Flat Washers 5/16" 
- (H9)x1 Allen Key 





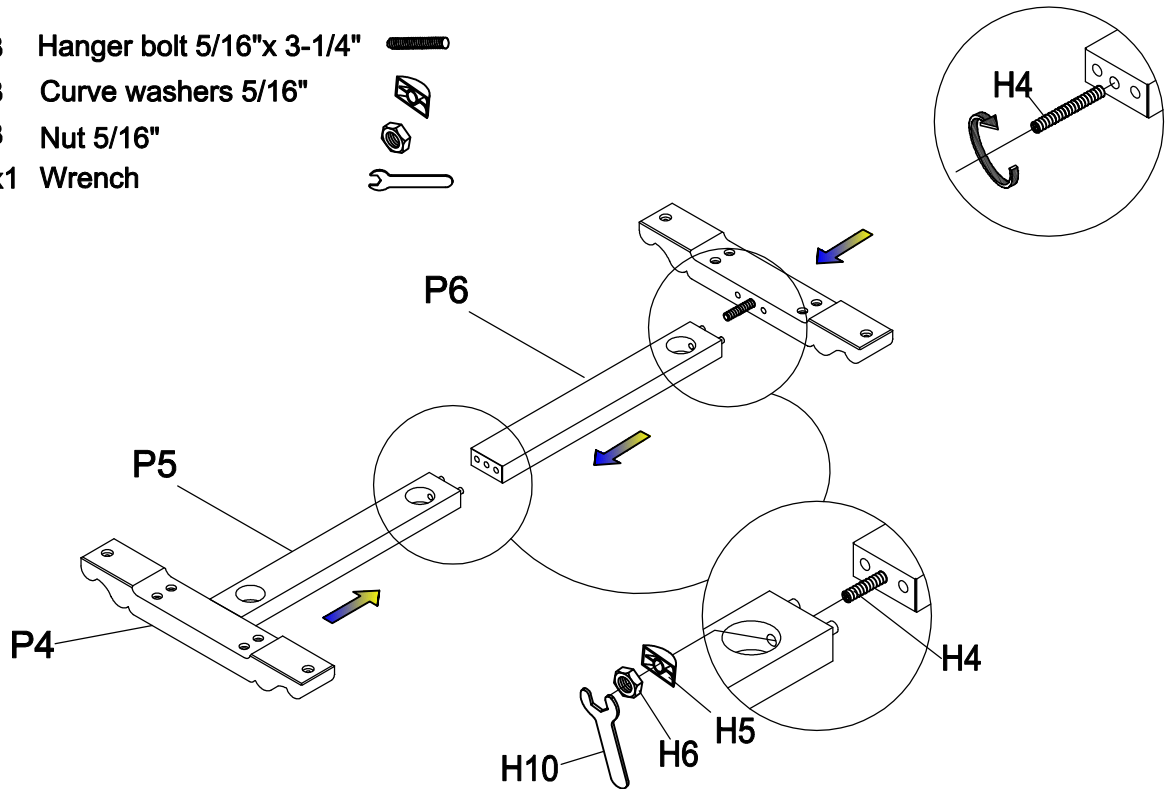

Step 3: Attach the Stretcher A (P5) to Stretcher B (P6) and then attach Stretcher (P5 & P6) to the Base (P4) as shown below.

- (H4)x3 Hanger bolt 5/16"x 3-1/4" 
- (H5)x3 Curve washers 5/16" 
- (H6)x3 Nut 5/16" 
- (H10)x1 Wrench 



Step 4: Attach the Leg Frames (P3) to the Table Top (P1) & (P2) as shown below, do not tighten Bolts.

- (H1)x10 Bolts 5/16" x 2" 
- (H7)x10 Lock Washers 5/16" 
- (H8)x10 Flat Washers 5/16" 
- (H9)x1 Allen Key 

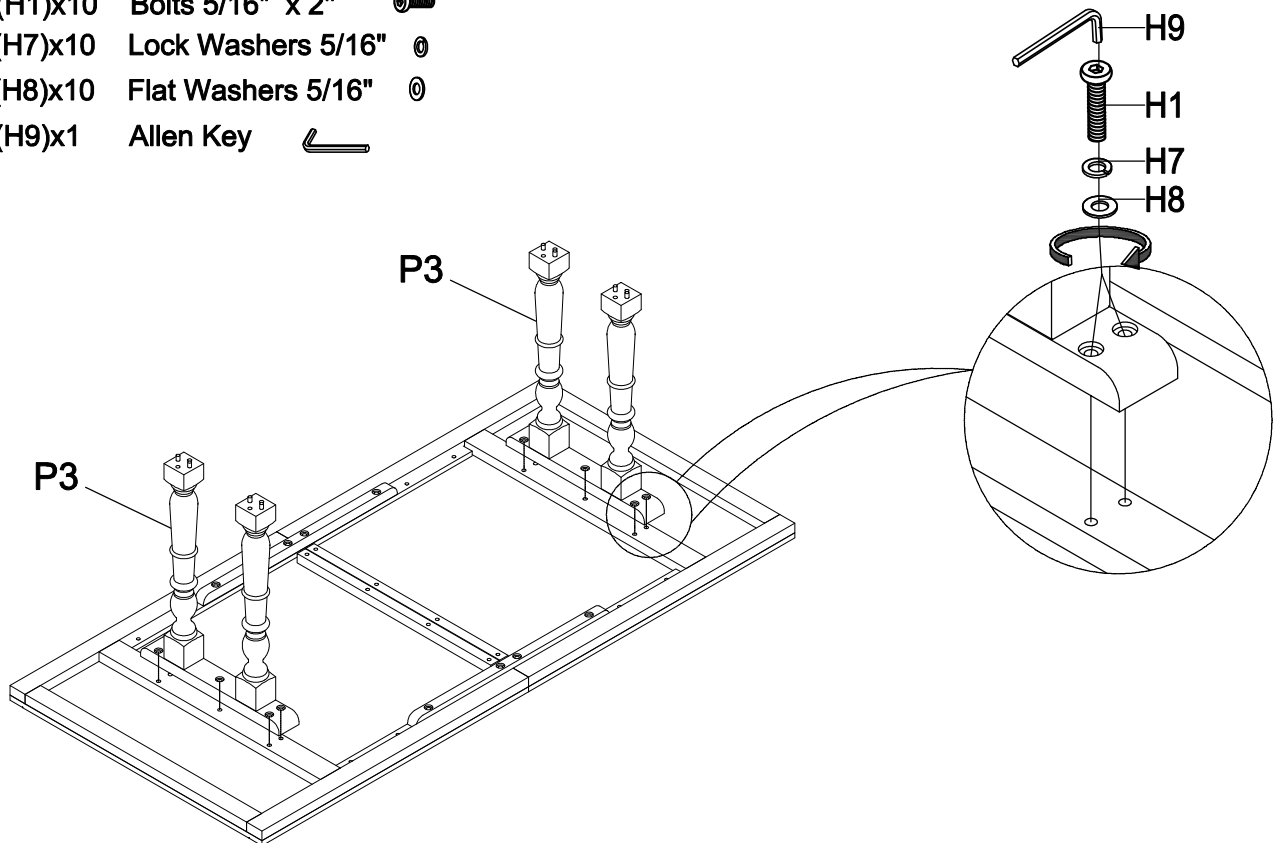

Step 5: Attach the Base Frame assembled in Step 3 to Leg Frames (P3) as shown below then tighten all Bolts.

- (H2)x8 Bolts 5/16" x 2" 
- (H7)x8 Lock Washers 5/16" 
- (H8)x8 Flat Washers 5/16" 
- (H9)x1 Allen Key 

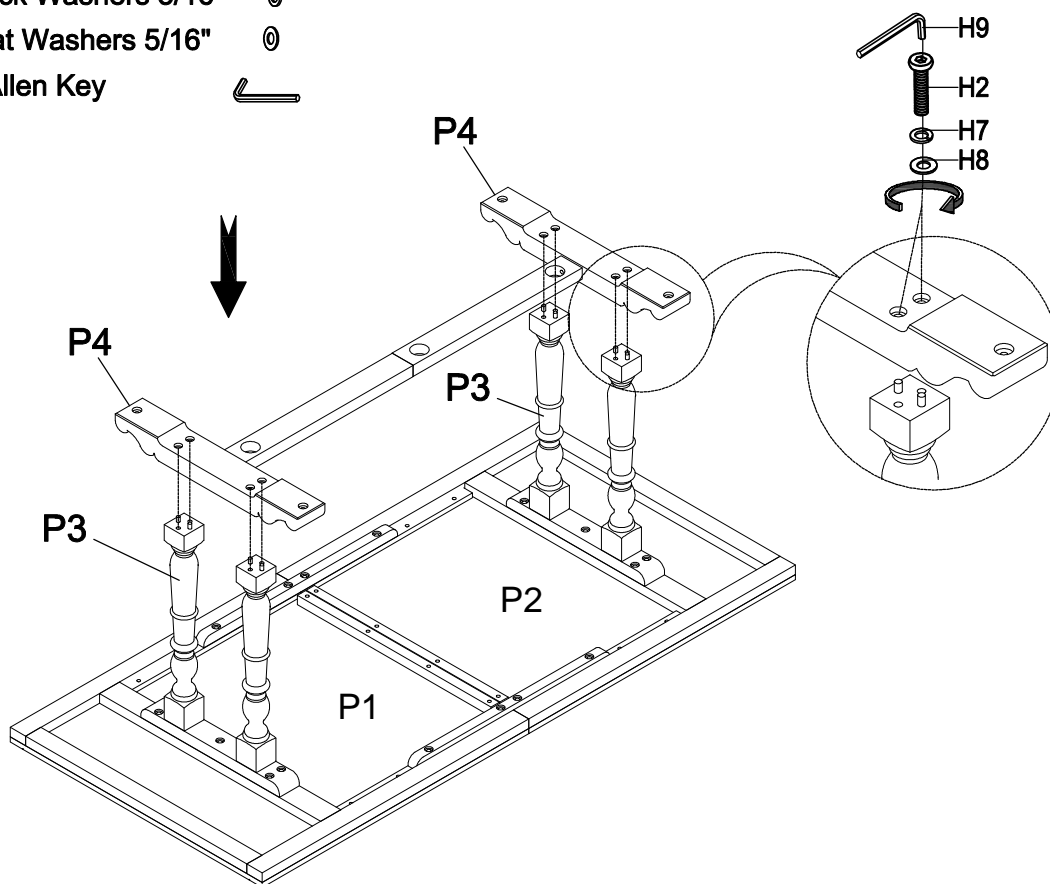

Step 6: Turn the assembled table to an upright position. Assembly is complete.

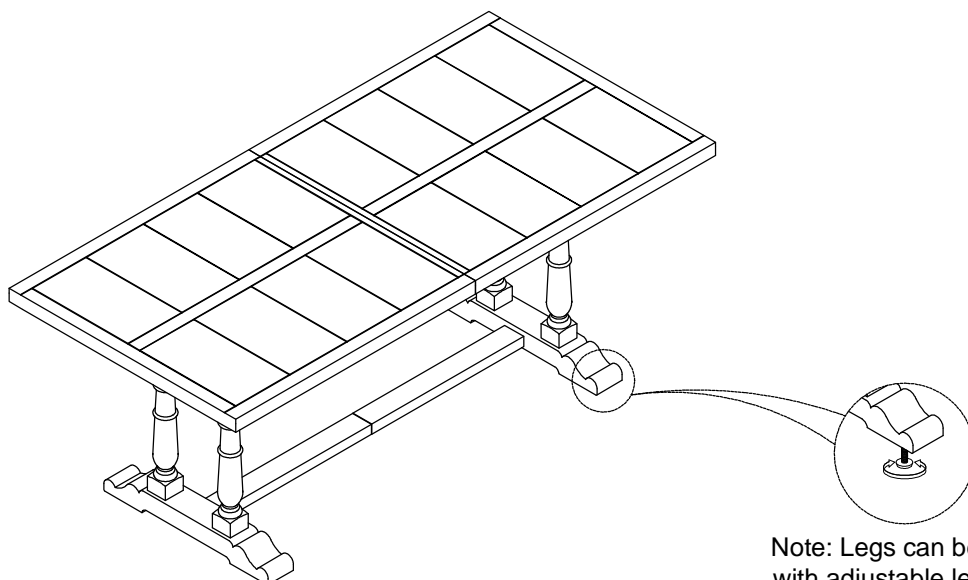

Note: Legs can be adjusted with adjustable levelers

ADDITIONAL NOTE ABOUT SAFETY: BOLTS MAY LOOSEN DURING NORMAL EVERYDAY USE. THEY SHOULD BE PERIODICALLY INSPECTED AND RE-TIGHTENED TO PREVENT DAMAGE OR INJURY. ALWAYS CHECK TO ENSURE THAT ALL HARDWARE IS KEPT TIGHTENED.

Thank you for your purchase