



Important safety instructions:

- Please read carefully all instructions before assembling.
- For your safety and ease, assembly by two or more adults is recommended.
- Keep instructions for future use.

Pre-assembly:



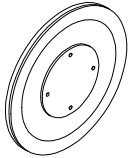

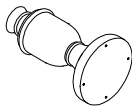
- Do not discard any content until assembly completed to avoid accidentally discarding small parts or hardware.
- Take out all parts and hardwares from box.

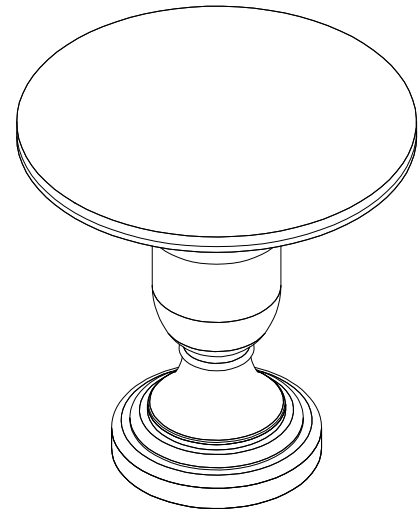
Parts List

Item	Description		QTY
P1	Table Top		1
P2	Mounting Plate		1
P3	Post		1



Hardware List

Item	Description		QTY
H1	Bolt (Ø5/16 * 1-1/2")		8
H2	Spring Washers Ø5/16 "		8
H3	Flat Washers Ø5/16"		8
H4	Allen Wrench		1

DISCLAIMER:

WHEN PROPERLY ASSEMBLED, THIS ITEM IS SAFE FOR INTENDED USE. SELLER IS NOT LIABLE FOR ANY DAMAGES RESULTING FROM ITEM BEING IMPROPERLY ASSEMBLED AFTER PURCHASE.

Assembly Procedures:

Step 1. Assemble the table on a flat, soft surface such as a carpet or cloth to prevent scratching the finish. Attach post (P3) to mounting plate (P2) using bolts (H1), lock washers (H2) and flat washers (H3) as shown below.

(H1)x4 Bolts



(H2)x4 Spring Washers



(H3)x4 Flat Washers



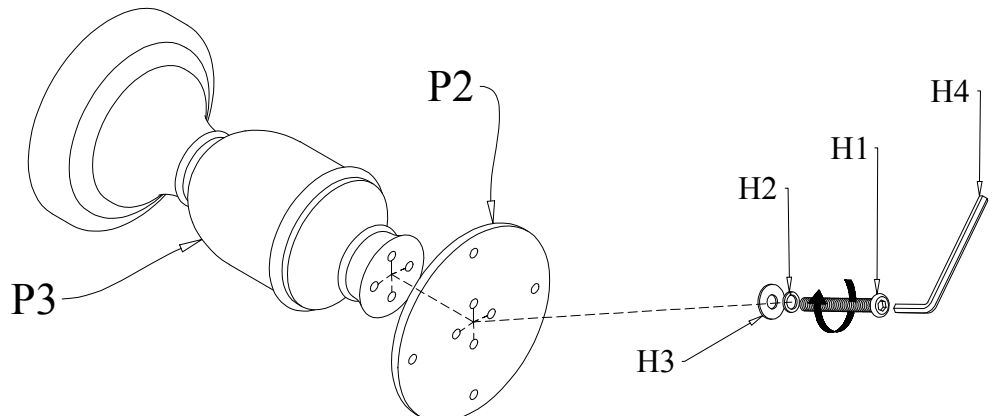

(H4) Allen Wrench



Thank you for your purchase

Step 2. Loosely attach the mounting plate (P2) to table top (P1) using bolts (H1), lock washers (H2) and flat washers (H3) as shown below.

- (H1)x4 Bolts 
- (H2)x4 Spring Washers 
- (H3)x4 Flat Washers 
- (H4) Allen Wrench 

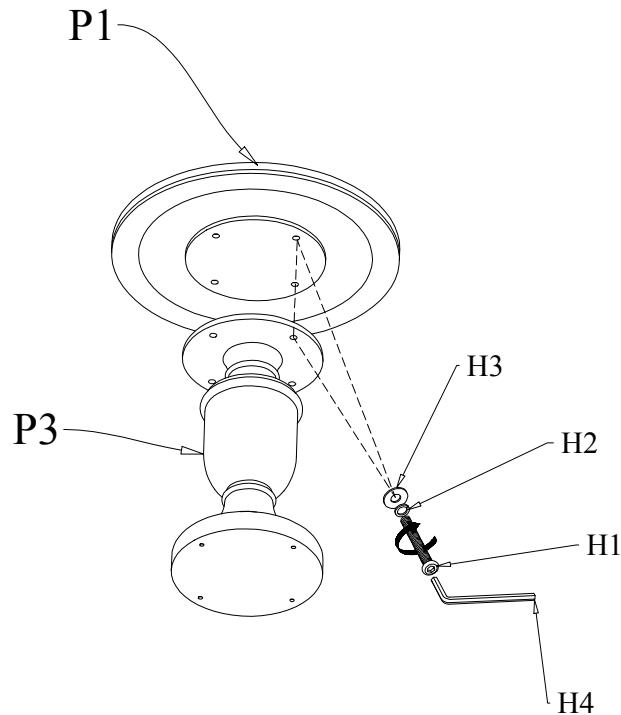

Step 3.

1) Securely tighten all bolts with Allen wrench (H4). Turn the assembled table to an upright position.

2) Assembly is complete. **Failure to follow these instructions may cause the bolts to misalign during assembly.**

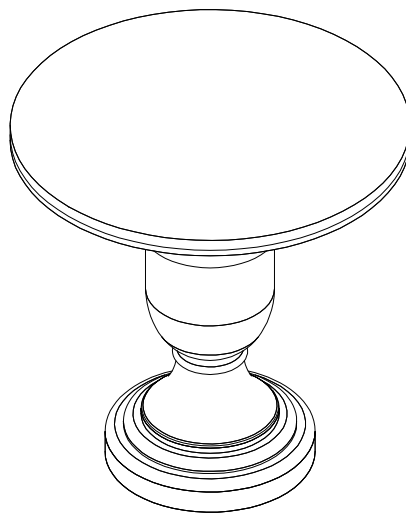

ADDITIONAL NOTE ABOUT SAFETY: BOLTS MAY LOOSEN DURING NORMAL EVERYDAY USE. THEY SHOULD BE PERIODICALLY INSPECTED AND RE-TIGHTENED TO PREVENT DAMAGE OR INJURY. ALWAYS CHECK TO ENSURE THAT ALL HARDWARE IS KEPT TIGHTENED.

Thank you for your purchase